

CAN terminator  
 (for the first and the last node  
 of the network available via SW5)

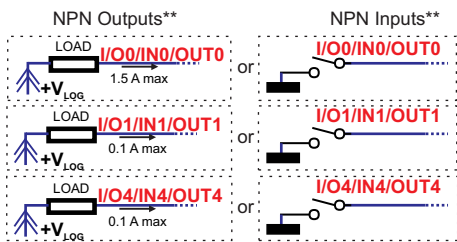

Logic power supply

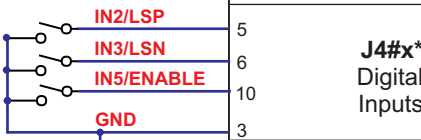
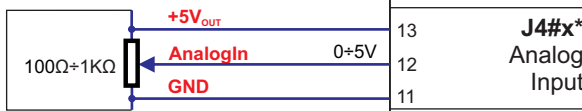
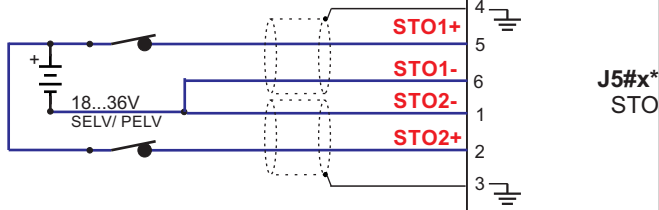
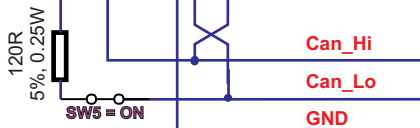
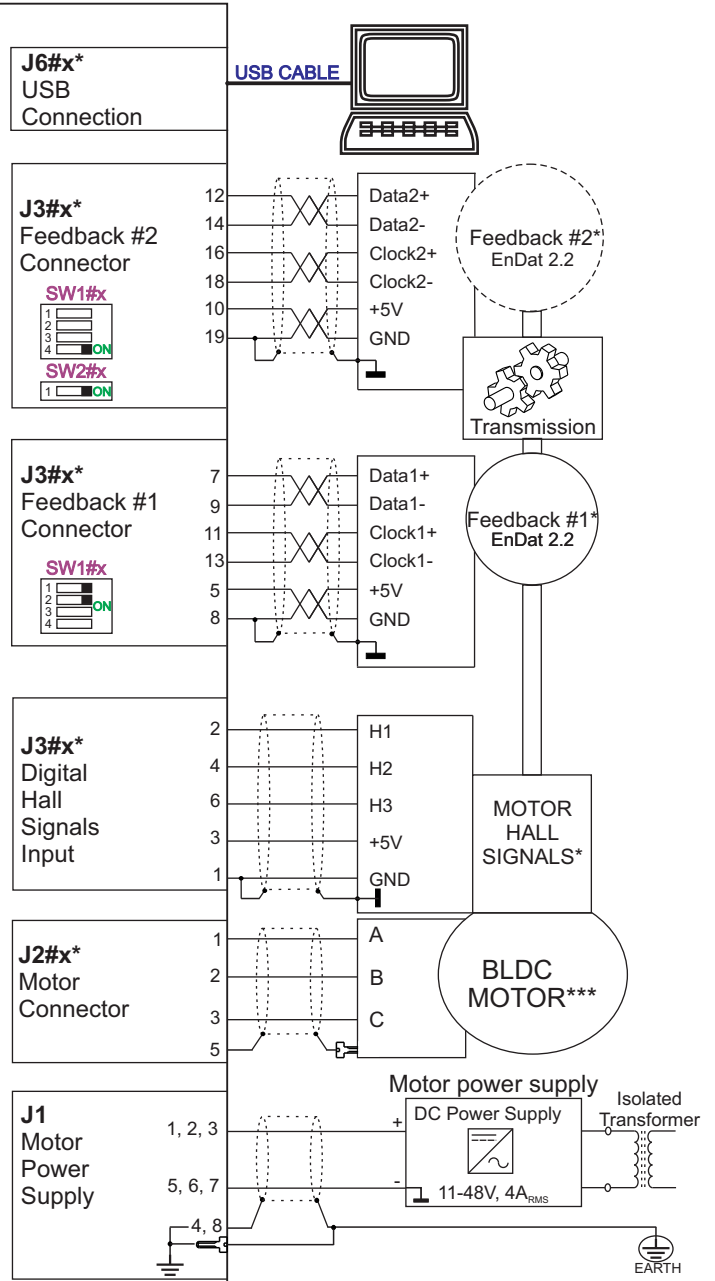
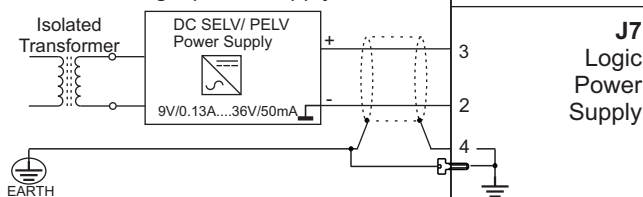

\* "x" can be drive 1, 2, 3 for P020.103.E403 or 1, 2, 3, 4 for P020.103.E404

\*\* ANY OF THE THREE PINS ARE SOFTWARE SELECTABLE INDIVIDUALLY AS NPN INPUTS/OUTPUTS

\*\*\* FOR ALL AVAILABLE OPTIONS CHECK THE USER MANUAL OF THE DRIVE

<b>Micro 4804 SX-CAN-STO Multi Axis System</b>			
Copyright © Technosoft 2024. All rights reserved.			
	<b>Micro 4804 SX3-CAN-STO</b>	P/N:P020.103.E403	
	<b>Micro 4804 SX4-CAN-STO</b>	P/N:P020.103.E404	
Size <b>A4</b>	Document Number: P091.020.Micro 4804 SX-CAN-STO.CDG.0924	Author: ALN	Rev <b>A</b>
Date: 0924	Sheet 1 of 1		