

CAN terminator
(for the first and the last node of the network available via SW1)

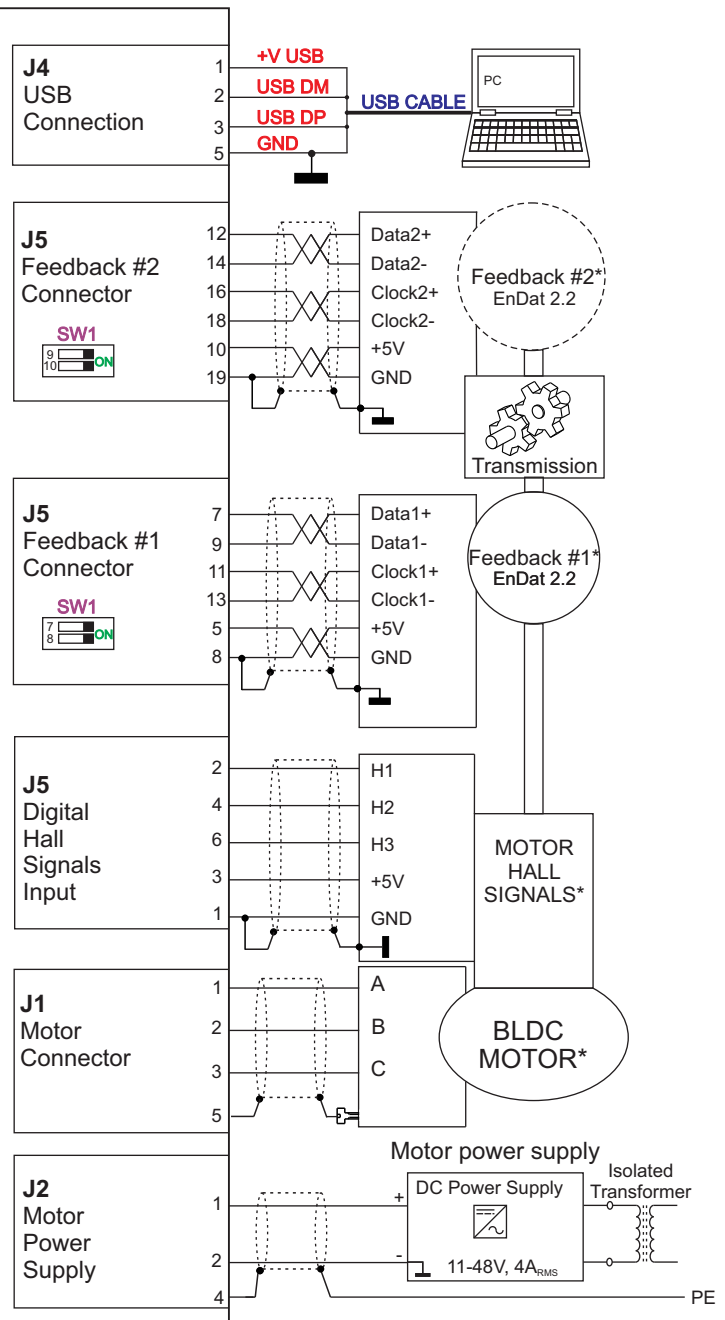
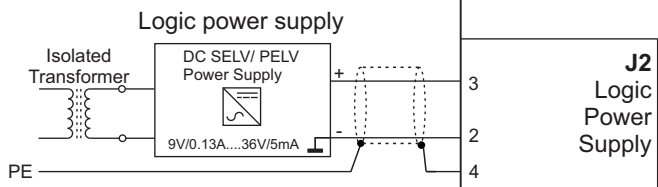
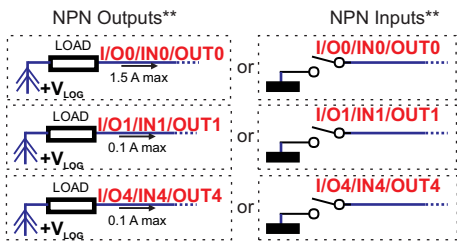
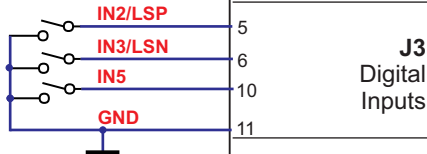
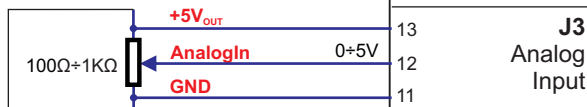
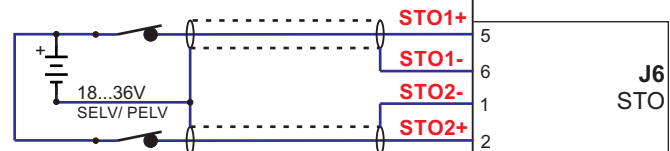
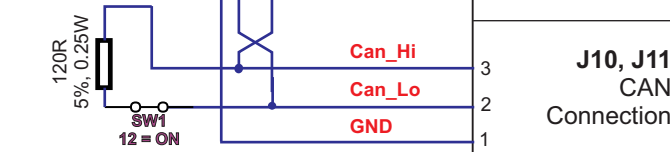

* FOR ALL AVAILABLE OPTIONS CHECK THE USER MANUAL OF THE DRIVE
 ** ANY OF THE THREE PINS ARE SOFTWARE SELECTABLE INDIVIDUALLY AS NPN INPUTS/OUTPUTS

Micro 4804 CZ-CAN-STO		P/N:P020.803.E202	
Copyright © Technosoft 2024. All rights reserved.			
Micro 4804 CZ-CAN-STO Title Electrical Connection Diagram			
Size A4	Document Number: P091.020.Micro 4804 CZ-CAN-STO.CDG.1024	Author: ALN	Rev B
Date: 1024	Sheet 1 of 1		