

EtherCAT Port0 IN

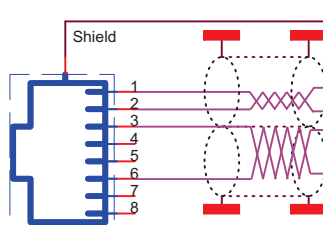

EtherCAT Port1 OUT

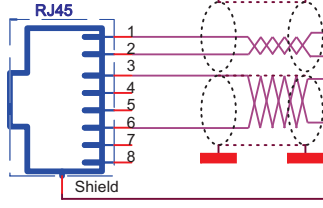
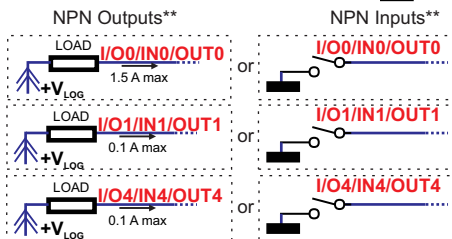
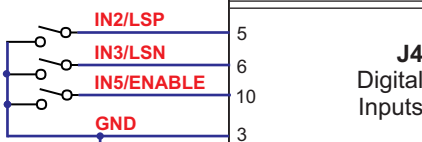
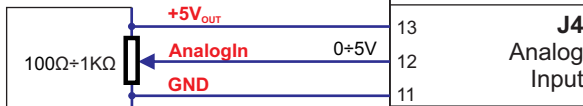

Logic power supply

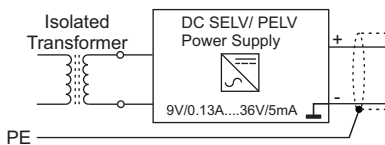

Motor power supply

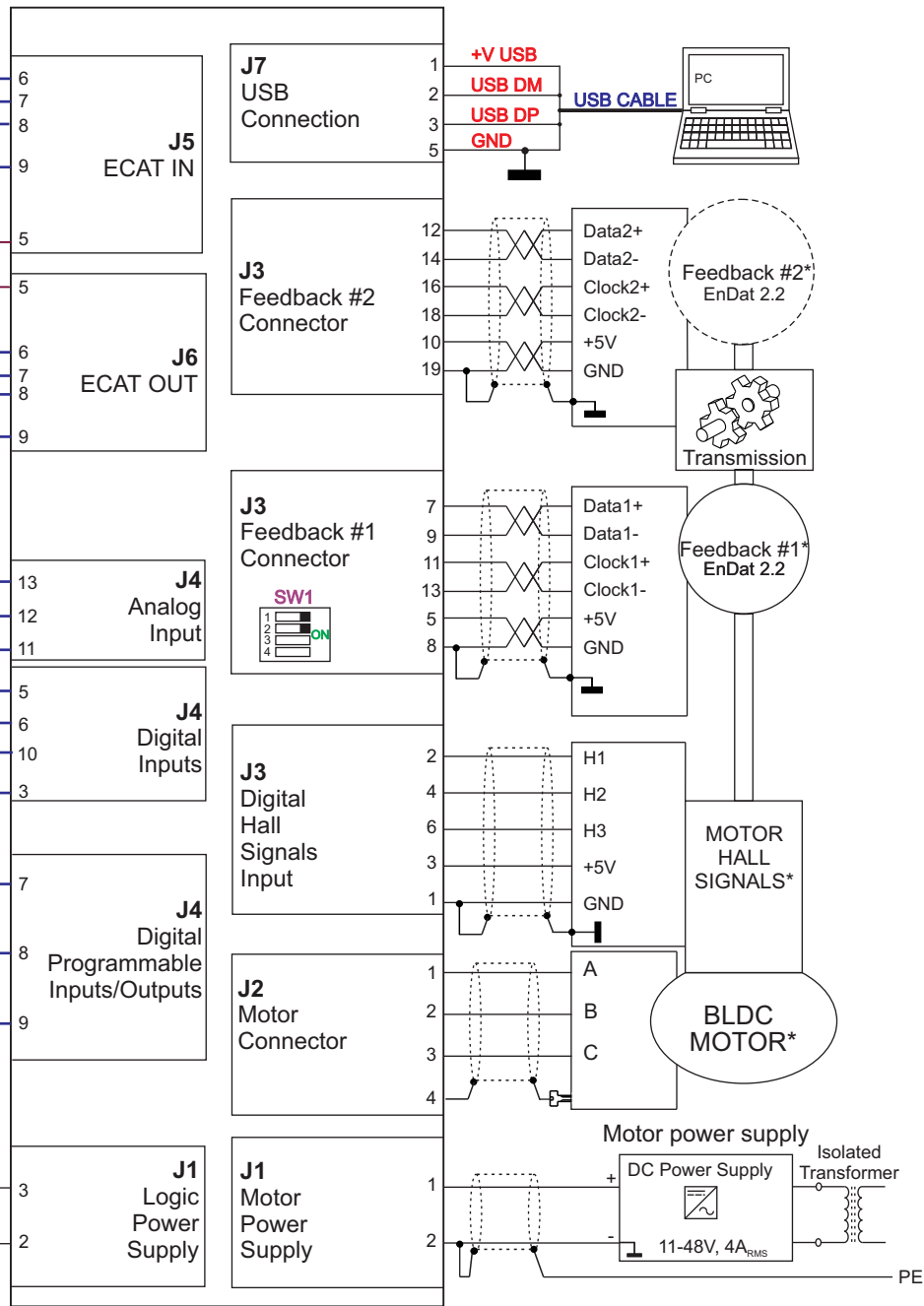
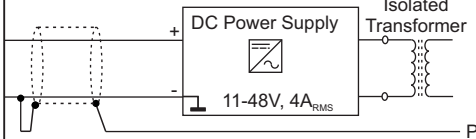

* FOR ALL AVAILABLE OPTIONS CHECK THE USER MANUAL OF THE DRIVE
 ** ANY OF THE THREE PINS ARE SOFTWARE SELECTABLE INDIVIDUALLY AS NPN INPUTS/OUTPUTS

Micro 4803 CZ-CAT		P/N:P020.801.E222	
Copyright © Technosoft 2023. All rights reserved.			
Micro 4803 CZ-CAT Microdrive EtherCAT Title Electrical Connection Diagram			
Size A4	Document Number: P091.020.Micro 4803 CZ-CAT.CDG.0523	Author: ALN	Rev D
Date: 0523	Sheet 1 of 1		