

# Micro 4803 SY4-CAT Multi Axis System DATASHEET P/N: P020.200.E404

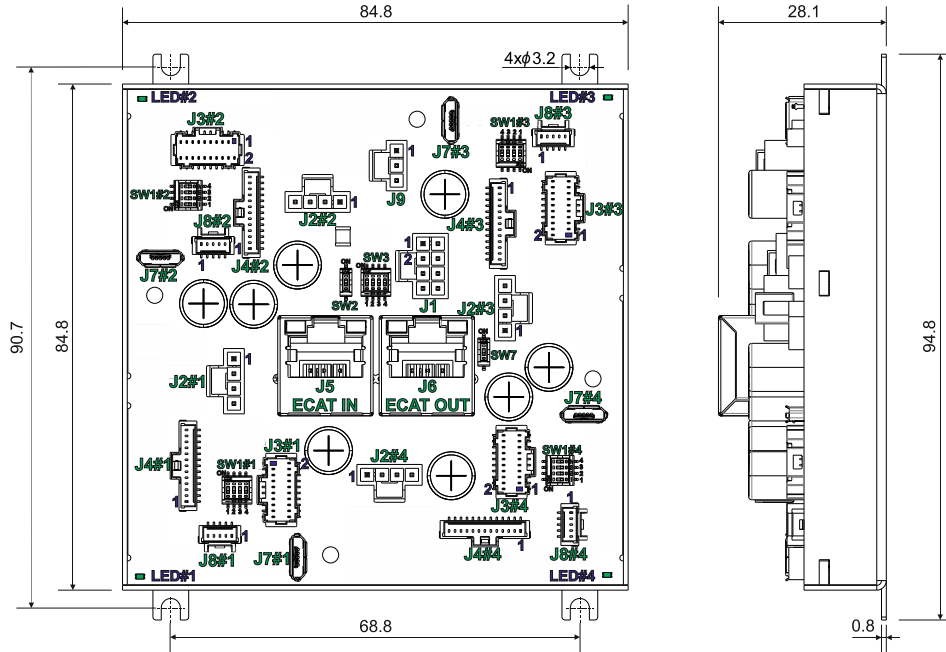

All dimensions are in mm. Drawing not to scale.

## Motor – sensor configurations

Sensor	Motor		
	PMSM	BLDC	DC BRUSH
Incr. Encoder	Y		Y
Incr. Encoder + Dig. Hall	Y	Y	
Linear Halls	Y		
Digital Halls control only	Y		
SSI / BiSS-C/ EnDAT/ TAMAGAWA/ Panasonic/ Nikon / Sanyo Denki	Y	Y	Y
Tacho			Y

## Features

- 4 axis compact CAN motion system
- Universal solution for control of rotary and linear brushless and brushed motors
- One supply connector: Motor 7 to 48 V<sub>DC</sub>. Logic 6 to 48 V<sub>DC</sub>
- Motor output current per axis:
  - Nominal: 4A<sub>RMS</sub> / 5.6A amplitude nominal;
  - Peak: 10A<sub>RMS</sub> / 14A amplitude peak.
- Feedback Devices per axis (1x Hall sensors + 2x encoders):
  - 1 x Hall sensor interface (digital or linear)
  - 1st feedback devices supported:
    - Incremental A / B (index Z available only for 1 encoder): differential or single-ended
    - Absolute: differential or single-ended encoder. Supported protocols: SSI, BiSS, EnDAT, TAMAGAWA, Panasonic, Nikon, Sanyo Denki
    - pulse & direction interface (single-ended or differential) for external (master) digital reference
  - 2nd feedback devices supported:
    - Incremental encoder interface (differential)
    - Absolute differential encoder. Supported protocols: SSI, BiSS, EnDAT, TAMAGAWA, Panasonic, Nikon, Sanyo Denki
    - pulse & direction interface (differential) for external (master) digital reference
- Integrated termination resistors for the 1st feedback connector of each axis, selectable by Sliding switches
- 1 x analogue input software selectable per axis: 12-bit 0-5V or ±10V: Reference, Feedback or general purpose
- 3 x digital inputs per axis: 2 for limit switches + one Enable, NPN, pull-to-GND to activate, pull-up on-board to +5V. Pull to GND to activate
- 3 x configurable I/Os per axis, each software selectable as:
  - Digital input, NPN, with pull-up on-board to +5V. Pull to GND to activate;
  - Digital output, NPN (open-collector), with pull-up on-board to +5V. Sink current: 1 x 1.5A to drive inductive loads (such as mechanical brake), 2 x 0.1A.
- RS-232 serial & USB & dual 100Mbps EtherCAT® interfaces
- Commissioning (set-up) possible through RS232, USB, FoE (File-over-EtherCAT) or EoE (Ethernet-over-EtherCAT)
- EtherCAT connection: standard RJ45 ports
- Operating ambient temperature: 0-40°C (over 40°C with de-rating)
- Programmable protections: any short-circuit between motor phases, GND and/or supply, over/under-voltage, over-current, I<sup>2</sup>t, control error
- >99% voltage efficiency

Name ALN	First edition June 22, 2021	Document template: P099.TQT.564.0001	Last edition November 2, 2023	Visa: AS
<b>TECHNOSOFT</b>		Title of document	N° document	
		<b>Micro 4803 SY4-CAT Multi Axis System PRODUCT DATA SHEET</b>	<b>P020.200.E404.10M.DSH</b>	Page: 1 of 5

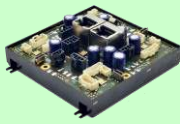

# Micro 4803 SY4-CAT Multi Axis System DATASHEET P/N: P020.200.E404

Mating Connectors			
Producer	Part No.	Connector	Description
Molex	1053071203	J9	1x3 Nano-Fit, 2.50mm Pitch Nano-Fit Wire-to-Board Housing, 3 circuits
Molex	1053071204	J2#x	1x4 Nano-Fit, 2.50mm Pitch Nano-Fit Wire-to-Board Housing, 4 circuits
Molex	5011892010	J3#x	2x10 Pico-Clasp, 1.00mm Pitch Pico-Clasp Wire-to-Board Housing, 20 Circuits
Molex	5013301300	J4#x	1x13 Pico-Clasp, 1.00mm Pitch Pico-Clasp Wire-to-Board Housing, 13 Circuits
Molex	1053081208	J1	Nano-Fit Receptacle Housing, TPA Capable, 2.50mm Pitch, Dual Row, 8 Circuits, Black, Glow-Wire Capable
Molex	5013300500	J8#x	Pico-Clasp Receptacle Crimp Housing, 1.00mm Pitch, Single Row, Friction Lock, 5 Circuits, White
Tensility International Corp	1002333	J7#x	USB cable, Cable USB A Male - Micro B Male, 1m, shielded, black, 9.6mm plastic width
Molex	0797582140	J1, J9 J2#x	Pre-Crimped wires for Nano-Fit   Cable Assembly, Nano-Fit Crimp Terminal Socket to Nano-Fit Crimp Terminal Socket, 300mm
Molex	0797581019	J3#x, J4#x, J8#x	Pre-Crimped wires for Pico-Clasp   Cable Assembly, Pico-Clasp Crimp Terminal Socket to Pico-Clasp Crimp Terminal Socket, 300mm
Molex	1053001400	J1, J9 J2#x	Pins for Nano-Fit   Nano-Fit Crimp Terminal, Female, 0.76µm Gold (Au) Plating, Lubricated, 24-26 AWG
Molex	5011937000	J3#x, J4#x, J8#x	Pins for Pico-Clasp   1.00mm Pitch, Pico-Clasp Female Crimp Terminal, Gold Plating 0.10µm, 28-32 AWG, Reel
Molex	638276000	J1, J9 J2#x	Crimp tool Nano Fit   Crimp Tool, Ratchet, Molex Nano-Fit 105300 Series 26-24AWG Socket Contacts, 207129 Series
Molex	638191500	J3#x, J4#x, J8#x	Crimp tool Pico-Clasp   Crimp Tool, Ratchet, Molex Pico-Clasp 501193 & 501334 Series 32-28AWG Contacts

\* "x" can be drive 1, 2, 3 or 4

Pin	Name	Type	Description
J1 1,2,3	+Vmot	I	Positive terminal of the motor supply: 7 to 48 V <sub>DC</sub> . Internally connected to all 4 drives +V <sub>mot</sub> pins.
4	PE	-	Earth connection.
5,6,7	GND	-	Ground return.
8	PE	-	Earth connection

Pin	Name	Type	Description
J2#x 1	A	O	Phase A for 3-ph motors, Motor+ for DC brush motors.
2	B	O	Phase B for 3-ph motors, Motor- for DC brush motors.
3	C	O	Phase C for 3-ph motors.
4	PE	-	Earth connection

Pin	Name	Type	Description
J4#x 1	232TX	O	RS-232 Data Transmission.
2	232RX	I	RS-232 Data Reception.
3	GND	-	Ground return.
4	+Vlog	I	Positive terminal of the logic supply input: 6 to 48 V <sub>DC</sub> . Internally connected to other +V <sub>log</sub> pins.
5	IN2/LSP	I	5-60V digital NPN input. Positive limit switch input.
6	IN3/LSN	I	5-60V digital NPN input. Negative limit switch input.
7	I/O0	I/O	5-50V NPN general-purpose digital programmable input IN0 /or NPN 1.5A output OUT0.
8	I/O1	I/O	5-50V NPN general-purpose digital programmable input IN1 / or NPN 0.1A output OUT1.
9	I/O4	I/O	5-50V NPN general-purpose digital programmable input IN4 / or NPN 0.1A output OUT4.
10	IN5/Enable	I	5-60V digital NPN input. Drive Enable input.
11	GND	-	Ground return.
12	AnalogIn	I	Analog input (range software selectable 0-5V or ±10V)
13	+5V	O	Supply for all feedback sensors.

Pin	Name	Type	Description
1	GND	-	Ground return.
2	Hall1	I	Digital Hall, or Linear Hall sensor 1.
3	+5V	O	5V supply for all feedback sensors.
4	Hall2	I	Digital Hall, or Linear Hall sensor 2.
5	+5V	O	5V supply for all feedback sensors.
6	Hall3	I	Digital Hall, or Linear Hall sensor 3.
7	EncA1+/EncA1 Dt1+/Dt1	I	Encoder 1 A / data positive (differential or single-ended). Set SW1 pin 1 for differential.
8	GND	-	Ground return.
9	EncA1-/Dt1-	I	Encoder 1 A - / data negative (differential) or Pulse-, or Data- for SSI, or Slave- for BiSS. Set SW1 pin 1 for differential.
10	+5V	O	5V supply for all feedback sensors.
11	EncB1+/EncB1 Clk1+/Clk1	I	Encoder 1 B / clock positive (differential or single-ended). Set SW1 pin 2 for differential.
J3#x 12	EncA2+/EncA2 Dt2+/Dt2	I	Incr. encoder2 A+ diff. input, or Pulse+, or Data+ for SSI, or Master+ for BiSS; has 120Ω resistor between pins 12 and 14.
13	EncB1/ Clk1-	I	Encoder 1 B - / clock negative (differential). Set SW1 pin 2 for differential.
14	EncA2-/Dt2-	I	Incr. encoder2 A- diff. input, or Pulse-, or Data- for SSI, or Master- for BiSS; has 120Ω resistor between pins 12 and 14.
15	Z1+	I	Incr. encoder1 Z single-ended or Z+ diff. input. Set SW1 pin 3 for differential.
16	EncB2+/EncB2 Clk2+/Clk2	I/O	Incr. encoder2 B+ diff. input, or Dir+, or Clock+ for SSI, or Master+ for BiSS; has 120Ω resistor between pins 16 and 18.
17	Z1-	I	Incr. encoder1 Z- diff. input. Set SW1 pin 3 for differential.
18	EncB2- Clk2-	I	Incr. encoder2 B- diff. input, or Dir-, or Clock- for SSI, or Master- for BiSS; has 120Ω resistor between pins 16 and 18.
19	GND	-	Ground return.
20	+Vlog	I	Positive terminal of the logic supply input: 6 to 48 V <sub>DC</sub> . Internally connected to other +V <sub>log</sub> pins.

Port	Name	Type	Description
J5	ECAT IN	I	EtherCAT standard RJ45 Ethernet IN port.
J6	ECAT OUT	O	EtherCAT standard RJ45 Ethernet OUT port.
J7#x	USB	I/O	Standard Micro USB for PC data transfer

Pin	Name	Type	Description
J8#x 1	+Vlog	I	Positive terminal of the logic supply input: 6 to 48 V <sub>DC</sub> . Internally connected to other +V <sub>log</sub> pins.
2	IN2/LSP	I	5-60V digital NPN input. Positive limit switch input. Internally connected to J4#x pin 5.
3	IN3/LSN	I	5-60V digital NPN input. Negative limit switch input. Internally connected to J4#x pin 6.
4	GND	-	Ground return.
5	PE	-	Earth connection

Pin	Name	Type	Description
J9 1	Rsvd	-	Reserved. Do not connect.
2	GND	-	Ground return.
3	+Vlog	I	Positive terminal of the logic supply input: 6 to 48 V <sub>DC</sub> . Internally connected to all 4 drives +V <sub>log</sub> pins.

SW1#x – Feedback Resistors selection	
Position	Description
1	ON = Connect an 120Ω resistor between EncA1-/Dt1- and EncA1+/EncA1/Dt1+/Dt1 feedback pins.
2	ON = Connect an 120Ω resistor between EncB1/Clk1- and EncB1+/EncB1/Clk1+/Clk1 feedback pins.
3	ON = Connect an 120Ω resistor between Z1- and Z1+ feedback pins.
4	Reserved.

Name ALN	First edition June 22, 2021	Document template: P099.TQT.564.0001	Last edition November 2, 2023	Visa: AS
		Title of document <b>Micro 4803 SY4-CAT Multi Axis System PRODUCT DATA SHEET</b>	N° document <b>P020.200.E404.10M.DSH</b>	Page: 2 of 5



# Micro 4803 SY4-CAT Multi Axis System DATASHEET P/N: P020.200.E404

SW7 - Reserved									
SW2 & SW3 - AxisID Selection									
SW2	SW3				Drive AxisID				
	Pin 1	Pin 2	Pin 3	Pin 4	Drive #1	Drive #2	Drive #3	Drive #4	
off	off	off	off	off	1	2	3	4	
off	off	off	off	on	9	10	11	12	
off	off	off	on	off	17	18	19	20	
off	off	off	on	on	25	26	27	28	
off	off	on	off	off	33	34	35	36	
off	off	on	off	on	41	42	43	44	
off	off	on	on	off	49	50	51	52	
off	off	on	on	on	57	58	59	60	
off	on	off	off	off	65	66	67	68	
off	on	off	off	on	73	74	75	76	
off	on	off	on	off	81	82	83	84	
off	on	off	on	on	89	90	91	92	
off	on	on	off	off	97	98	99	100	
off	on	on	off	on	105	106	107	108	
off	on	on	on	off	113	114	115	116	
off	on	on	on	on	121	122	123	124	
on	off	off	off	off	129	130	131	132	
on	off	off	off	on	137	138	139	140	
on	off	off	on	off	145	146	147	148	
on	off	off	on	on	153	154	155	156	
on	off	on	off	off	161	162	163	164	
on	off	on	off	on	169	170	171	172	
on	off	on	on	off	177	178	179	180	
on	off	on	on	on	185	186	187	188	
on	on	off	off	off	193	194	195	196	
on	on	off	off	on	201	202	203	204	
on	on	off	on	off	209	210	211	212	
on	on	off	on	on	217	218	219	220	
on	on	on	off	off	225	226	227	228	
on	on	on	off	on	233	234	235	236	
on	on	on	on	off	241	242	243	244	
on	on	on	on	on	249	250	251	252	

**LEDs**  
Each LED#x (yellow) shows if the corresponding drive logic supply is powered and if its internal +5V power supply is operational.

## Electrical characteristics

- All parameters measured under the following conditions (unless otherwise specified):
- $V_{LOG} = 24 \text{ VDC}$ ;  $V_{MOT} = 48 \text{ VDC}$ ;  $F_{PWM} = 20 \text{ kHz}$
  - Supplies start-up / shutdown sequence: -any-
  - Load current (sinusoidal amplitude) = 5.6A
  - Data is provided for each axis of the system

Operating Conditions		Min.	Typ.	Max.	Units
Ambient temperature		0		40 <sup>1</sup>	°C
Ambient humidity	Non-condensing	0		90	%Rh
Altitude / pressure <sup>2</sup>	Altitude (vs. sea level)	-0.1	0 ± 2.5	2	Km
	Ambient Pressure	0 <sup>2</sup>	0.75 ± 1	10.0	atm
Storage Conditions		Min.	Typ.	Max.	Units
Ambient temperature		-40		100	°C
Ambient humidity	Non-condensing	0		100	%Rh
Ambient Pressure		0		10.0	atm
ESD capability (Human body model)	Not powered; applies to any accessible part			±0.5	kV
	Original packaging			±15	kV

Mechanical Mounting		Min.	Typ.	Max.	Units	
Airflow		natural convection <sup>3</sup> , closed box				
Spacing required for horizontal mounting	Between adjacent drives		10		mm	
	Between drives and nearby walls		10		mm	
	Space needed for drive removal		20		mm	
Insertion force	Using recommended mating connectors		20		N	
			8		N	
Environmental Characteristics		Min.	Typ.	Max.	Units	
Size (Length x Width x Height)	Global size	84.8 x 68.8 x 28.1			mm	
		~3.3 x 2.7 x 1.1			inch	
Weight		-			g	
Cleaning agents	Dry cleaning is recommended	Only Water- or Alcohol- based				
Protection degree	According to IEC60529	IP20			-	
Logic Supply Input (+V <sub>LOG</sub> )		Min	Typ	Max.	Units	
Supply voltage	Nominal values	6	24	48	V <sub>DC</sub>	
	Absolute maximum values, drive operating but outside guaranteed parameters	4.9		60	V <sub>DC</sub>	
	Absolute maximum values, continuous	-0.5		63	V <sub>DC</sub>	
Supply current	+V <sub>LOG</sub> = 12V		90	150	mA	
	+V <sub>LOG</sub> = 24V		60	90		
	+V <sub>LOG</sub> = 48V		45	60		
Voltage Measurement - Total error					1.5	%
Utilization category   Acc. to 60947-4-1 (I <sub>PEAK</sub> ≤ 1.05 * I <sub>NOM</sub> )					DC-1	
Motor Supply Input (+V <sub>MOT</sub> )		Min	Typ.	Max.	Units	
Supply voltage	Nominal values	7		48	V <sub>DC</sub>	
	Absolute maximum values, drive operating but outside guaranteed parameters	6		60	V <sub>DC</sub>	
	Absolute maximum values, continuous	-0.5		63	V <sub>DC</sub>	
Supply current	Idle		25		mA	
	Operating	-15	±3	+15		
	Absolute maximum value, short-circuit condition (Duration ≤ 10ms) <sup>†</sup>			16.5		
Voltage Measurement - Total error					1.5	%
Utilization category   Acc. to 60947-4-1 (I <sub>PEAK</sub> ≤ 4.0 * I <sub>NOM</sub> )					DC-3	
Motor Outputs (A/A+, B/A-, C)		Min.	Typ.	Max.	Units	
Nominal current	PMSM motors sinusoidal amplitude			5.6	A	
	PMSM motors sinusoidal RMS			4	A <sub>RMS</sub>	
	DC/BLDC motors continuous			4.85	A	
Peak current	maximum 2.5s	-14		+14	A	
Short-circuit protection threshold		±16.5		±18	A	
Short-circuit protection delay		2		4	µs	
On-state voltage drop	Nominal output current; including typical mating connector contact resistance		0.1		V	
Off-state leakage current				0.3	1	mA
Voltage Efficiency				92		%
Motor inductance (phase-to-phase)	Recommended value, for current ripple max. ±5% of full range; +V <sub>MOT</sub> = 48 V	F <sub>PWM</sub>			µH	
		20 kHz		900		
		40 kHz		480		
		60 kHz		320		
		80 kHz		240		
	Minimum value, limited by short-circuit protection; +V <sub>MOT</sub> = 48 V	20 kHz		270	µH	
		60 kHz		150		
		40 kHz		100		
		80 kHz		80		
		100 kHz		60		
Motor electrical time-constant (L/R)	Recommended value for ±5% current measurement error	20 kHz		330	µs	
		40 kHz		170		
		60 kHz		140		
		80 kHz		80		
		100 kHz		66		
Current measurement	FS = Full Scale accuracy		±2	±3	%FS	
Supply Output (+5V)		Min.	Typ.	Max.	Units	
Output voltage	Current sourced = 400mA	5.05	5.2	5.25	V	
Output current <sup>4</sup>	24V motor	650		800	mA	
Short-circuit to GND protection		Yes / Drive resets at event				
Over-voltage protection		NOT protected				
ESD protection	Human body model	±1			KV	

<sup>1</sup> Operating temperature at higher temperatures is possible with reduced current and power ratings  
<sup>2</sup> Micro 4803 can be operated in vacuum (no altitude restriction), but at altitudes over 2,500m, current and power rating are reduced due to thermal dissipation efficiency.

<sup>3</sup> In case of forced cooling (conduction or ventilation) the spacing requirements may drop substantially down to zero as long as the ambient temperature is kept below the maximum operating limit  
<sup>4</sup> For more details see the "Current de-rating with +5V output current" graph

Name ALN	First edition June 22, 2021	Document template: P099.TQT.564.0001	Last edition November 2, 2023	Visa: AS
		Title of document <b>Micro 4803 SY4-CAT Multi Axis System PRODUCT DATA SHEET</b>	N° document <b>P020.200.E404.10M.DSH</b>	
			Page: 3 of 5	



# Micro 4803 SY4-CAT Multi Axis System DATASHEET P/N: P020.200.E404

Digital Inputs (IN0, IN1, IN2/LSP, IN3/LSN, IN4, IN5/ENA)		Min.	Typ.	Max.	Units
Mode compliance		NPN			
Default state		Logic HIGH			
Input voltage	Input floating (wiring disconnected)		1.4	1.8	V
	Logic "LOW"		3.1	2.5	
	Logic "HIGH"		0.9	1.1	
	Hysteresis		1.4	1.6	
	Logic "LOW"		4	3.5	
	Logic "HIGH"			0.6	
Floating voltage (not connected)			4.5		
Absolute maximum, continuous		-5		+55	
Input current	Logic "LOW"; Pulled to GND		9	10	mA
	Logic "HIGH"; Pulled to +24V			0.4	
Input frequency		0		500	kHz
Minimum pulse		1			µs
ESD protection		Human body model		±2	kV
Digital Outputs (OUT0, OUT1, OUT4)		Min.	Typ.	Max.	Units
Mode compliance		NPN 24V			
Default state		High-Z (floating)			
Immediately after power-up		Logic "HIGH"			
Output voltage	Logic "LOW"; output current = 1.5A for OUT0/ 0.05A for the other digital outputs			0.4	V
	Logic "HIGH"; output current = 0, no load	4	4.5	5	
	Logic "HIGH", external load to +V <sub>LOG</sub>		V <sub>LOG</sub>		
	Absolute maximum, continuous (free-wheeling diodes to +V <sub>LOG</sub> to GND)	-0.5		V <sub>LOG</sub> +0.5	
	Absolute maximum, surge (duration ≤ 1s)	-1		V <sub>LOG</sub> +1	
Output current	Logic "LOW", sink current, short duration, duty cycle ≤ 1%	5s max	OUT1, OUT4	0.1	A
			OUT0	2	
	Logic "HIGH", source current; external load to GND; V <sub>OUT</sub> ≥ 2.0V	0.5s max	OUT1, OUT4	0.15	A
			OUT0	2.5	
Logic "HIGH", leakage current; external load to +V <sub>LOG</sub> ; V <sub>OUT</sub> = V <sub>LOG</sub> max = 40V				0.05	0.1
Minimum pulse width		0.5			µs
ESD protection		Human body model		±15	kV
Encoder Inputs (A+, A-, B+, B-, Z+, Z-, A2+, A2-, B2+, B2-) <sup>1</sup>		Min.	Typ.	Max.	Units
Single-ended mode compliance		Leave A1-, B1-, Z1-, A2-, B2- floating			
Single-ended threshold		TTL/CMOS/Open-collector (NPN)			
Single-ended input current		1.2	1.3	1.5	V
Differential mode compliance		Input pulled to GND against on-board 2.2 KΩ pull-up to 5V			
Differential mode compliance		For full RS422 compliance, see <sup>2</sup>			
Input voltage	Hysteresis	±0.03	±0.05	±0.2	V
	Differential mode	-15		+15	
	Common-mode range (A+ to GND, etc.)	-7		+12	
Input impedance, differential	A+, A2+, B+, B2+, Z+, Z2+		2.2		kΩ
	A-, A2-, B-, B2-, Z-, Z2-		4.4		
Input frequency		0		15	MHz
Minimum pulse width		33			ns
ESD protection		Human body model		±30	kV

Hall Inputs (Hall1, Hall2, Hall3)		Min.	Typ.	Max.	Units	
Mode compliance		TTL / CMOS / Open-collector (NPN sink), or analog (linear) 0...5V				
Default state		Input floating (Wiring disconnected)				
Input voltage	Digital	Logic "LOW"	4.5	4.7	5	V
		Logic "HIGH"		1.5	1.7	
	Hysteresis		3	2.5		
Analog			0	0.5...4.5	4.95	
Input current	Logic "LOW"; Pull to GND			2.3	mA	
	Logic "HIGH"; Internal 2.2KΩ pull-up to 5V			0		
Minimum pulse width			70		µs	
ESD protection		Human body model		±15	kV	
RS-232		Min.	Typ.	Max.	Units	
Compliance		TIA/EIA-232-C				
Bit rate		Software selectable		9600	115200	
Short-circuit		232TX short to GND		Guaranteed		
ESD protection		Human body model		±2	kV	
ESD protection		Human body model		±1	kV	
Absolute encoder interface: SSI, BiSS-C, EnDAT, Tamagawa, Nikon, Sanyo Denki		Min.	Typ.	Max.	Units	
Differential mode (CLOCK, DATA)		For full RS422 compliance, see <sup>2</sup>		TIA/EIA-422-A		
CLOCK (DATA) Output voltage	Differential; 50Ω differential load	1.5	3.3		V	
	Common-mode, referenced to GND	1	1.7	3		
CLOCK frequency		Software selectable		1000, 2000, 3000, 4000	kHz	
CLOCK (DATA) Short-circuit protection		Common-mode voltage ±15V		Yes, protected		
DATA format	Software selectable		Binary / Gray			
			Single-turn / Multi-turn			
			Counting direction			
DATA resolution	Single-turn		56			
	Multi-turn and single-turn		56			
	If total resolution >31 bits, some bits must be ignored by software setting to achieve a max 31 bits resolution					
Analog Inputs (REF, FDBK)		Min.	Typ.	Max.	Units	
0...5V Mode						
Input voltage	Operational range	0		4.95	V	
	Absolute maximum values, continuous	-12		+18		
	Absolute maximum, surge (duration ≤ 1s)			±36		
Input impedance		To 1.447V		20	kΩ	
Resolution				12	bits	
Integral linearity				±2	bits	
Offset error				±10	bits	
Gain error				±1%	% FS <sup>3</sup>	
Bandwidth (-3dB)		Software selectable		0	1.5	
ESD protection		Human body model		±2	kV	
±10V Mode		Min.	Typ.	Max.	Units	
Differential voltage range				±10	V	
Common-mode voltage range		Referenced to GND	-12	0...10	+50	
Input impedance		To 1.447V		20	kΩ	
Resolution				12	bits	
Integral linearity				0.036	%FS <sup>3</sup>	
Offset error		Common-mode voltage = 0...10 V		±0.2	±0.5	
Gain error				±0.5	±3	
Bandwidth (-3dB)		Software selectable		0	5.5	
EtherCAT®		Min.	Typ.	Max.	Units	
Compliance		IEEE802.3, IEC61158				
Transmission line specification		According to TIA/EIA-568-5-A		Cat. 5e.UTP		
J5, J6 pinout		EtherCAT® supports MDI/MDI-X auto-crossover		TIA/EIA-568-A or TIA/EIA-568-B		
Software protocols compatibility		CoE, CiA402, IEC61800-7-301				
Node addressing		By software		1 + 255		
		By Hardware				
MAC addressing		none				
ESD protection		Human body model		±15	kV	

<sup>1</sup> Full RS-422 compatibility, as well as noise rejection improvement the setting of SW1 pins 1, 2, 3 for each signal pair (A1+/A1-, B1+/B1-, Z1+/Z1-) is needed

<sup>2</sup> Full RS-422 compatibility, as well as noise rejection improvement the setting of SW1 pins 1, 2, 3 for each signal pair (A1+/A1-, B1+/B1-, Z1+/Z1-) is needed

<sup>3</sup> "FS" stands for "Full Scale"

Name ALN	First edition June 22, 2021	Document template: P099.TQT.564.0001	Last edition November 2, 2023	Visa: AS
		Title of document <b>Micro 4803 SY4-CAT Multi Axis System PRODUCT DATA SHEET</b>	N° document <b>P020.200.E404.10M.DSH</b>	
			Page: 4 of 5	

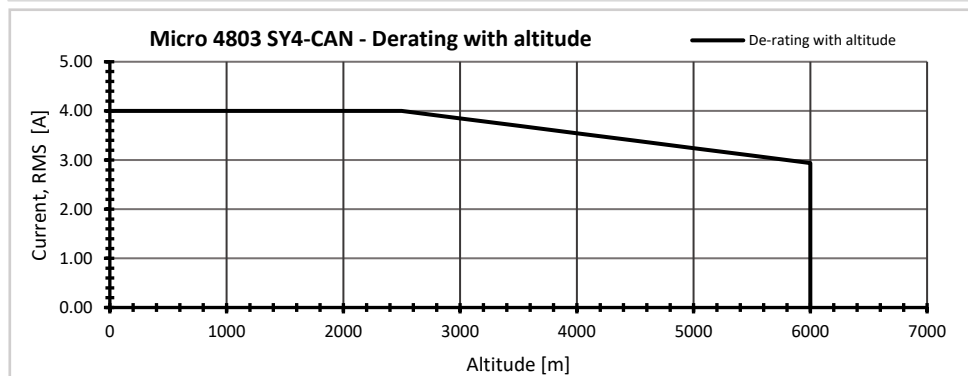
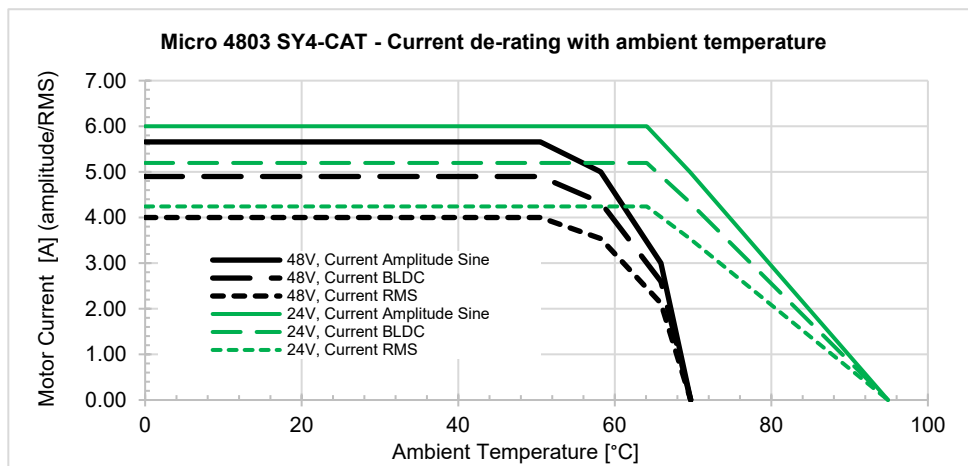
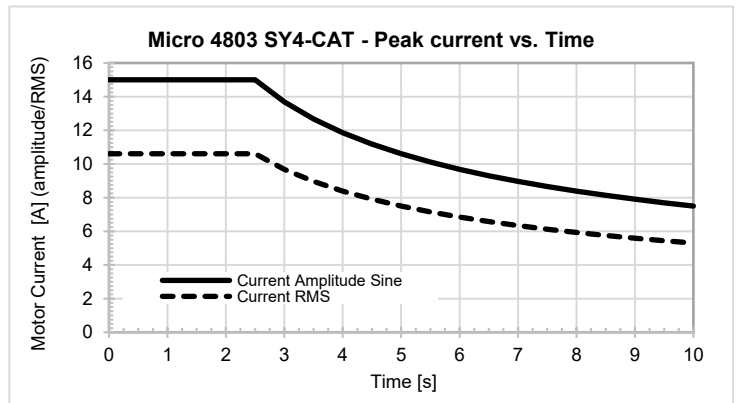
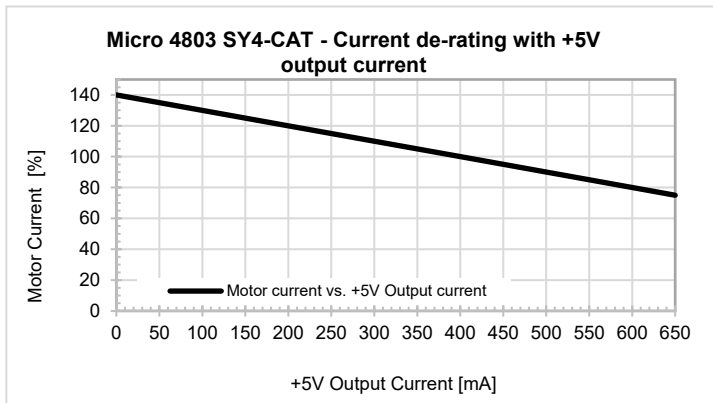
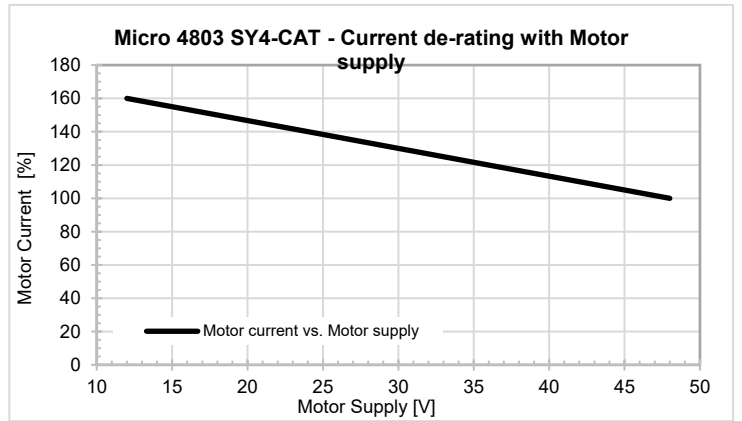
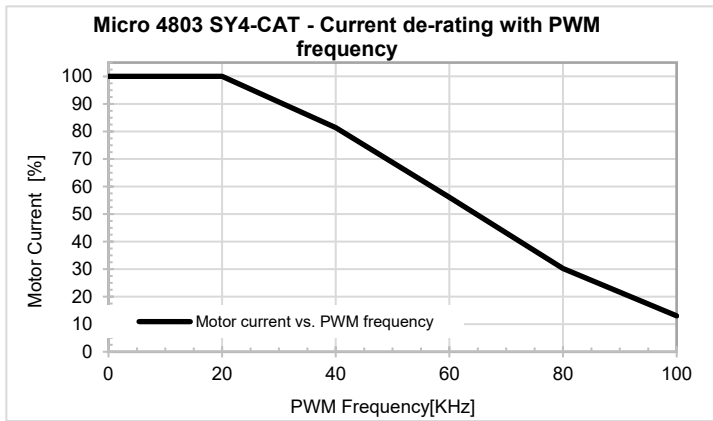

Name ALN	First edition June 22, 2021	Document template: P099.TQT.564.0001	Last edition November 2, 2023	Visa: AS
		Title of document <b>Micro 4803 SY4-CAT Multi Axis System PRODUCT DATA SHEET</b>	N° document <b>P020.200.E404.10M.DSH</b>  Page: 5 of 5	