

Micro 4804 SX4-CAN-STO Multi Axis System DATASHEET

P/N: P020.103.E404

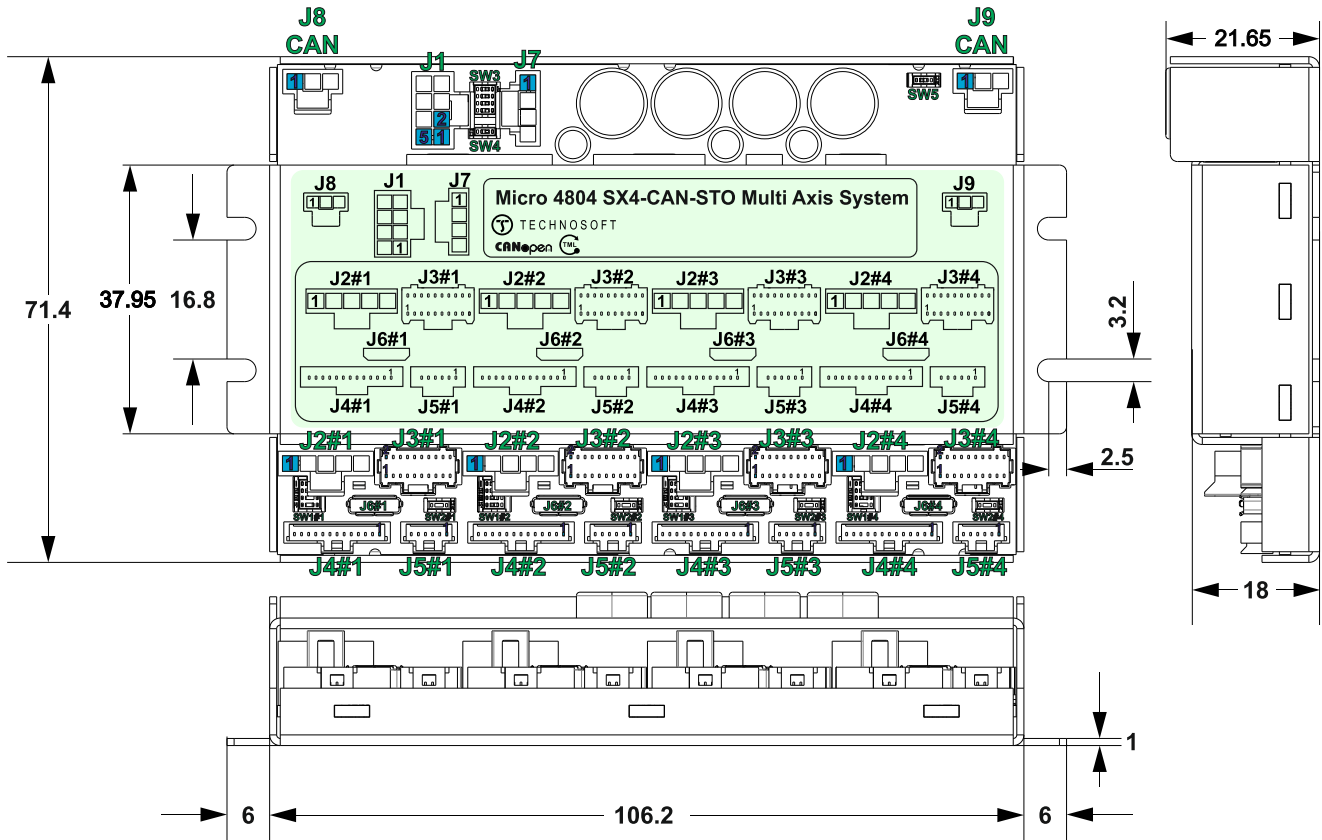

All dimensions are in mm. Drawing not to scale.

Motor – sensor configurations

Sensor	Motor				
	PMSM	BLDC	DC BRUSH	STEP (2-ph)	STEP (3-ph)
Incr. Encoder	Ⓢ		Ⓢ	Ⓢ	
Incr. Encoder + Dig. Hall	Ⓢ	Ⓢ			
Linear Halls	Ⓢ				
Digital Hall control only	Ⓢ				
BISS / SSI / EnDAT / TAMAGAWA / Nikon / Sanyo Denki / Panasonic	Ⓢ	Ⓢ	Ⓢ	Ⓢ	
Tacho			Ⓢ		
Open-loop (no sensor)				Ⓢ	Ⓢ

Features

- Compact 4-axis CAN motion system that integrates a motion controller and drive into a single unit, powered by MotionChip™ technology.
- Universal solution for control of rotary and linear brushless, brushed and 2 or 3-phase step motors
- Advanced motion control features, including CSP, CSV, CST, PVT, S-curve, electronic gearing, camming, and more.
- Motor supply: 48V nominal
- Motor output current per axis:
 - Nominal: 5.7A_{RMS} / 8A amplitude for PMSM motors
7A for DC / BLDC / Step motors
 - Peak: 11.3A_{RMS} / 16A amplitude
- Logic supply: 24V nominal, 48V max

- Feedback Devices per axis:
 - 1 x Hall sensor interface (digital or linear)
 - Feedback#1 and Feedback#2 can be:
 - Incremental encoder A / B (index Z only for Feedback #1): differential or single-ended;
 - Absolute encoder: differential or single-ended. Supported protocols: SSI, BiSS, EnDAT, Tamagawa, Panasonic, Nikon, Sanyo Denki.
- Integrated termination resistors for each axis's feedback connectors, selectable via sliding switches
- 1 x analogue input per axis, 12-bit, software selectable: 0-5V or ±10V; Reference, Feedback or General purpose
- 3 x digital inputs per axis: 2 for limit switches + one general-purpose, NPN, pull-up on-board to +5V. Pull to GND to activate.
- 3 x configurable I/Os per axis, each software selectable as:
 - Digital input, NPN, with pull-up on-board to +5V. Pull to GND to activate;
 - Digital output, NPN (open-collector), with pull-up on-board to +5V. Sink current: 1 x 1.5A to drive inductive loads (such as mechanical brake), 2 x 0.1A.
- Communication interfaces: RS232; USB; TMLCAN and CANopen (CiA 301 v4.2, CiA 305 v.2.2.13 and CiA 402 v3.0) protocols
- STO: 2 safe torque-off inputs, safety integrity level (SIL3/Cat3/PLe) acc. to EN61800-5-1; -2/ EN61508-3; -4/ EN ISO 13849-1.
- 24Kwords E²ROM per axis to store setup data, TML motion programs, cam tables and other user data
- 16Kwords SRAM memory per axis for data acquisition
- Operating ambient temperature: 0-40°C (over 40°C with de-rating)
- Programmable protections: any short-circuit between motor phases, GND and/or supply, over/under-voltage, over-current, I²t drive & motor, control error
- >98% voltage efficiency, >98% power efficiency

Name ALN	First edition September 2, 2024	Document template: P099.TQT.564.0001	Last edition January 14, 2025	Visa:
TECHNOSOFT		Title of document Micro 4804 SX4-CAN-STO Multi Axis System PRODUCT DATA SHEET	N° document P020.103.E404.DSH.10C	Page: 1 of 5

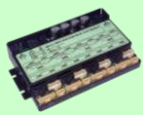

Micro 4804 SX4-CAN-STO Multi Axis System DATASHEET P/N: P020.103.E404

Mating Connectors				
Producer	Part No.	Connector	Description	
Molex	1053071203	J8, J9	1x3 Nano-Fit, 2.5mm Pitch Nano-Fit Wire-to-Board Housing, 3 circuits	
Molex	1053071204	J7	1x4 Nano-Fit, 2.5mm Pitch Nano-Fit Wire-to-Board Housing, 4 circuits	
Molex	1053071205	J2#x1	1x5 Nano-Fit, 2.5mm Pitch Nano-Fit Wire-to-Board Housing, 5 circuits	
Molex	5011892010	J3#x1	2x10 Pico-Clasp, 1mm Pitch Pico-Clasp Wire-to-Board Housing, 20 Circuits	
Molex	5013301300	J4#x1	1x13 Pico-Clasp, 1mm Pitch Pico-Clasp Wire-to-Board Housing, 13 Circuits	
Molex	1053081208	J5#x1	1x6 Pico-Clasp, 1mm Pitch Pico-Clasp Wire-to-Board Housing, 6 Circuits	
Molex	5013300600	J1	Nano-Fit Receptacle Housing, TPA Capable, 2.5mm Pitch, Dual Row, 8 Circuits, Black, Glow-Wire Capable	
Tensility International Corp	1002333	J1, J7, J8, J9, J2#x1	USB cable, Cable USB A Male - Micro B Male, 1m, shielded, black, 9.6mm plastic width	
Molex	0797582140	J1, J7, J8, J9, J2#x1	Pre-Crimped wires for Nano-Fit	Cable Assembly, Nano-Fit Crimp Terminal Socket to Nano-Fit Crimp Terminal Socket, 300mm
Molex	0797581019	J3#x1, J4#x1, J5#x1	Pre-Crimped wires for Pico-Clasp	Cable Assembly, Pico-Clasp Crimp Terminal Socket to Pico-Clasp Crimp Terminal Socket, 300mm
Molex	1053001400	J1, J7, J8, J9, J2#x1	Pins for Nano-Fit	Nano-Fit Crimp Terminal, Female, 0.76µm Gold (Au) Plating, Lubricated, 24-26 AWG
Molex	5011937000	J3#x1, J4#x1, J5#x1	Pins for Pico-Clasp	1.00mm Pitch, Pico-Clasp Female Crimp Terminal, Gold Plating 0.10µm, 28-32 AWG, Reel
Molex	638276000	J1, J7, J8, J9, J2#x1	Crimp tool Nano Fit	Crimp Tool, Ratchet, Molex Nano-Fit 105300 Series 26-24AWG Socket Contacts, 207129 Series
Molex	638191500	J3#x1, J4#x1, J5#x1	Crimp tool Pico-Clasp	Crimp Tool, Ratchet, Molex Pico-Clasp 501193 & 501334 Series 32-28AWG Contacts

Pin	Name	Type	Description
J1	1,2,3 +Vmot	I	Positive terminal of the motor supply: 7 to 48 V _{DC} . Internally connected to all 4 drives +V _{mot} pins.
	4 PE	-	Earth connection.
	5,6,7 GND	-	Ground return. Internally connected to other GND pins.
	8 PE	-	Earth connection

Pin	Name	Type	Description
J2#x1	1 A/A+	O	Phase A for 3-ph motors, A+ for 2-ph steppers, Motor+ for DC brush motors
	2 B/A-	O	Phase B for 3-ph motors, A- for 2-ph steppers, Motor- for DC brush motors
	3 C/B+	O	Phase C for 3-ph motors, B+ for 2-ph steppers
	4 Cr/B-	O	Chopping resistor / Phase B- for 2-ph steppers
	5 PE	-	Earth connection for motor cable shielding

Pin	Name	Type	Description
J4#x1	1 232TX	O	RS-232 Data Transmission.
	2 232RX	I	RS-232 Data Reception.
	3 GND	-	Ground return.
	4 +Vlog	I	Positive terminal of the logic supply input: 6 to 48 V _{DC} . Internally connected to other +V _{log} pins.
	5 IN2/LSP	I	5-48V digital NPN input. Positive limit switch input.
	6 IN3/LSN	I	5-48V digital NPN input. Negative limit switch input.
	7 I/O0	I/O	5-48V 1.5A NPN (sink) general-purpose digital programmable input IN0 or output OUT0
	8 I/O1	I/O	5-48V 0.1A NPN (sink) general-purpose digital programmable input IN1 or output OUT1
	9 I/O4	I/O	5-48V 0.1A NPN (sink) general-purpose digital programmable input IN4 or output OUT4
	10 IN5	I	5-48V digital general-purpose NPN input
	11 GND	-	Ground return. Internally connected to other GND pins.
	12 AnalogIn	I	Analog input (range software selectable 0-5V or ±10V)
	13 +5V	O	Supply for all feedback sensors.

Pin	Name	Type	Description
J3#x1	1 GND	-	Ground return. Internally connected to other GND pins.
	2 Hall1	I	Digital Hall, or Linear Hall sensor 1.
	3 +5V	O	5V supply for all feedback sensors.
	4 Hall2	I	Digital Hall, or Linear Hall sensor 2.
	5 +5V	O	5V supply for all feedback sensors.
	6 Hall3	I	Digital Hall, or Linear Hall sensor 3.
	7 EncA1+/EncA1 Dt1+/Dt1	I	Encoder 1 A+ / Data+ diff. input or single-ended input. Set SW1 pin 1 for differential.
	8 GND	-	Ground return.
	9 EncA1-/Dt1-	I	Encoder 1 A-/Data- diff. input. Set SW1 pin 1 for differential.
	10 +5V	O	5V supply for all feedback sensors.
	11 EncB1+/EncB1 Clk1+/Clk1	I	Encoder 1 B+ / Clock+ diff. input or single-ended input. Set SW1 pin 2 for differential.
	12 EncA2+/EncA2 Dt2+/Dt2	I	Incr. encoder 2 A / Data+ diff. input or single-ended input. Set SW1 pin 4 for differential.
	13 EncB1-/Clk1-	I	Encoder 1 B- / Clock- diff. input. Set SW1 pin 2 for differential.
	14 EncA2-/Dt2-	I	Incr. encoder 2 A- / Data - diff. input. Set SW1 pin 4 for differential.
	15 Z / Z1+	I	Incr. encoder 1 Z / Z+ diff. input or single-ended input. Set SW1 pin 3 for differential.
	16 EncB2+/EncB2 Clk2+/Clk2	I/O	Encoder 2 B+ / Clock+ diff. input or single-ended input. Set SW2 pin1 for differential.
	17 Z1-	I	Incr. encoder 1 Z- diff. input. Set SW1 pin 3 for differential.
	18 EncB2-/Clk2-	I	Encoder 2 B- / Clock- diff. input. Set SW2 pin1 for differential.
	19 GND	-	Ground return.
	20 +Vlog	I	Positive terminal of the logic supply input: 6 to 48 V _{DC} . Internally connected to other +V _{log} pins.

Pin	Name	Type	Description
J8, J9	1 GND	-	Ground return.
	2 Can Lo	I/O	CAN-Bus negative line (dominant low)
	3 Can Hi	I/O	CAN-Bus positive line (dominant high)

Port	Name	Type	Description
J6#x1	USB	I/O	Standard Micro USB for PC data transfer

Pin	Name	Type	Description
J5#x1	1 STO2-	I	Safe Torque Off input 2, negative return (opto-isolated, 0V) Apply between both STO1+, STO2+ and STO1-, STO2- 24V DC from SELV/ PELV power supply for motor PWM output operation
	2 STO2+	I	Safe Torque Off input 2, positive input (opto-isolated, 18+40V)
	3 PE	-	Earth connection
	4		
	5 STO1+	I	Safe Torque Off input 1, positive input (opto-isolated, 18+40V) Apply between both STO1+, STO2+ and STO1-, STO2- 24V DC from SELV/ PELV power supply for motor PWM output operation
	6 STO1-	I	Safe Torque Off input 1, negative return (opto-isolated, 0V)

Pin	Name	Type	Description
J7	1 Rsvd	-	Reserved. Do not connect.
	2 GND	-	Ground return. Internally connected to other GND pins.
	3 +Vlog	I	Positive terminal of the logic supply input: 6 to 48 V _{DC} . Internally connected to all 4 drives +V _{log} pins.
	4 PE	-	Earth connection

SW2#x1 – Feedback Resistors selection	
1	ON = Connect a 120Ω resistor between EncB2/Clk2- and EncB2+/EncB2/Clk2+/Clk2 feedback pins.

SW1#x1 – Feedback Resistors selection	
Position	Description
1	ON = Connect a 120Ω resistor between EncA1-/Dt1- and EncA1+/EncA1/Dt1+/Dt1 feedback pins.
2	ON = Connect a 120Ω resistor between EncB1/Clk1- and EncB1+/EncB1/Clk1+/Clk1 feedback pins.
3	ON = Connect a 120Ω resistor between Z1- and Z1+ feedback pins.
4	ON = Connect a 120Ω resistor between EncA2-/Dt2- and EncA2+/EncA2/Dt2+/Dt2 feedback pins.

¹ "x" can be drive 1, 2, 3 or 4

Name ALN	First edition September 2, 2024	Document template: P099.TQT.564.0001	Last edition January 14, 2025	Visa:
TECHNO SOFT		Micro 4804 SX4-CAN-STO Multi Axis System PRODUCT DATA SHEET	N° document P020.103.E404.DSH.10C	Page: 2 of 5

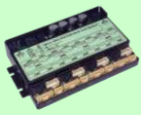

Micro 4804 SX4-CAN-STO Multi Axis System DATASHEET

P/N: P020.103.E404

SW5 – CAN Resistors selection							
1	ON = Connect an 120Ω resistor between CAN Hi and CAN Lo signals.						
SW4 – Protocol selection							
1	OFF – CANOpen mode						
	ON – TMLCAN mode						
SW3 – AxisID selection							
SW3				Drive AxisID			
Pin 1	Pin 2	Pin 3	Pin 4	Drive #1	Drive #2	Drive #3	Drive #4
off	off	off	off	1	2	3	4
off	off	off	on	9	10	11	12
off	off	on	off	17	18	19	20
off	off	on	on	25	26	27	28
off	on	off	off	33	34	35	36
off	on	off	on	41	42	43	44
off	on	on	off	49	50	51	52
off	on	on	on	57	58	59	60
on	off	off	off	65	66	67	68
on	off	off	on	73	74	75	76
on	off	on	off	81	82	83	84
on	off	on	on	89	90	91	92
on	on	off	off	97	98	99	100
on	on	off	on	105	106	107	108
on	on	on	off	113	114	115	116
on	on	on	on	121	122	123	124

Electrical characteristics

All parameters measured under the following conditions (unless otherwise specified):

- $V_{LOG} = 24$ VDC; $V_{MOT} = 48$ VDC; $F_{PWM} = 20$ kHz
- Ambient temperature = 25°C (typical values) / $0^{\circ}\text{C} \dots 40^{\circ}\text{C}$ (min/max values)
- Supplies start-up / shutdown sequence: -any-
- Load current = nominal
- Data is provided for each axis of the system

Operating Conditions		Min.	Typ.	Max.	Units
Ambient temperature		0		40 ¹	°C
Ambient humidity		Non-condensing		0	%Rh
Altitude / pressure ²		Altitude (vs. sea level)		0 ± 2.5	Km
		Ambient Pressure		0	10.0
Storage Conditions		Min	Typ	Max	Units
Ambient temperature		-40		100	°C
Ambient humidity		Non-condensing		0	%Rh
Ambient Pressure		0		10.0	atm
ESD capability (Human body model)		Not powered; applies to any accessible part		±5	kV
		Original packaging		±15	kV
Mechanical Mounting		Min	Typ	Max	Units
Airflow		natural convection, closed box			
Spacing required between adjacent drives		10			mm
Spacing required above drive		30		80	
		For counter-connectors & cable bending			
Environmental Characteristics		Min.	Typ.	Max.	Units
Size (Length x Width x Height)		118.2 x 71.4 x 21.7			mm
Global size		~4.65 x 2.81 x 0.85			inch
Weight		165			g
Cleaning agents		Dry cleaning is recommended			
Protection degree		Only Water- or Alcohol-based			
IP20		-			
Power dissipation		Idle ($I_{MOT} = 0\text{A}$)		1	1.2
		Full power ($I_{MOT} = \text{nominal}$)		2.0	2.4
Power efficiency		Full power ($I_{MOT} = \text{nominal}$)		98.7	
Voltage efficiency		$f_{PWM} = 20\text{KHz}$		98.3	%
		$f_{PWM} = 100\text{KHz}$		91.4	
Surface temperature of metallic baseplate		40			°C
Logic Supply Input (+V _{LOG})		Min	Typ.	Max.	Units
Supply voltage		Nominal values		6	24
		Absolute maximum values, drive operating but outside guaranteed parameters		4.9	50
		Absolute maximum values, continuous		-0.5	53
Supply current		+V _{LOG} = 12V		90	150
		+V _{LOG} = 24V		60	90
		+V _{LOG} = 48V		45	60
Utilization category		Acc. to 60947-4-1 ($I_{PEAK} \leq 1.05 \cdot I_{NOM}$)		DC-1	

Motor Supply Input (+V _{MOT})		Min	Typ.	Max.	Units
Supply voltage		Nominal values		7	48
		Absolute maximum values, drive operating but outside guaranteed parameters		6	50
		Absolute maximum values, continuous		-0.5	53
Supply current		Idle		0.3	mA
		Operating		±7	±16
Voltage measurement error				±0.15	±0.25
Utilization category		Acc. to 60947-4-1 ($I_{PEAK} \leq 4.0 \cdot I_{NOM}$)		DC-3	
Motor Outputs (A/A+, B/A-, C/B+, CR/B-)		Min.	Typ.	Max.	Units
Nominal current		PMSM motors sinusoidal amplitude		±8	A
		PMSM motors sinusoidal RMS		5.7	A _{RMS}
		DC/BLDC/STEP motors continuous		7	A
Peak current		maximum 4 seconds		-16	+16
Short-circuit protection threshold				±25	±28
Short-circuit protection delay				2.6	3.5
On-state voltage drop		Nominal output current; including typical mating connector contact resistance		50	70
Off-state leakage current				0.3	1
Current measurement		Accuracy (FS = Full Scale)		±1	±1.5
		Noise (current ≤ 2A)		±4	±6
		Noise (current ≥ 2A)		±30	±50
		Offset drift (compensated @ AxisOn)		±0.16	mA/°C
Motor inductance (phase-to-phase)		Recommended value to avoid spurious short-circuit protection, triggered by ripple			
		Fast loop ³ V_{MOT}			
		50µs 48V		133	
		100µs 48V		266	
		50µs 24V		66	
		100µs 24V		133	
Motor electrical time-constant (L/R)		Recommended value for ±5% current measurement error			
		$F_{PWM} = 20$ kHz		330	
		$F_{PWM} = 40$ kHz		170	
		$F_{PWM} = 60$ kHz		140	
		$F_{PWM} = 80$ kHz		80	
		$F_{PWM} = 100$ kHz		66	
Digital Inputs (IN0, IN1, IN2/LSP, IN3/LSN, IN4, IN5)		Min.	Typ.	Max.	Units
Mode compliance		NPN (sink)			
Default state		Input floating (wiring disconnected)			
Input voltage		Logic "LOW"		1.4	1.8
		Logic "HIGH"		3.1	2.5
		Hysteresis		0.9	1.1
		Logic "LOW"		1.4	1.6
		Logic "HIGH"		4	3.5
		Hysteresis		0.6	
		Floating voltage (not connected)		4.7	
		Absolute maximum, continuous		-2	+80
		IN2/LSP, IN3/LSN, IN5			
		IN0, IN1, IN4		-0.5	
				$V_{LOG} + 0.5$	
Input current		Logic "LOW"; Pulled to GND		6.5	8
		Logic "HIGH"; Pulled to +24V		0.2	0.4
Input frequency		Logic "HIGH"		0	500
Minimum pulse				1	
ESD protection - Human body model				±2	
Digital Outputs (OUT0, OUT1, OUT4)		Min.	Typ.	Max.	Units
Mode compliance		NPN (sink) 24V			
Load type		Resistive, Inductive			
Default state		Not supplied (+V _{LOG} floating)			
		Immediately after power-up			
		High-Z (floating)			
		Logic "HIGH"			
Output voltage		Logic "LOW"; output current = 1.5A for OUT0/ 0.05A for OUT1, OUT4		0.4	
		Logic "HIGH"; output current = 0, no load		4	4.7
		Logic "HIGH", external load to +V _{LOG}		V_{LOG}	
		Absolute maximum, continuous (free-wheeling diodes to +V _{LOG} to GND)		-0.5	$V_{LOG} + 0.5$
		Absolute maximum, surge (duration ≤ 1s) [†]		-1	$V_{LOG} + 1$
Output current		Logic "LOW", sink current, short duration, duty cycle ≤ 1%		5s max OUT1, OUT4	
		0.5s max OUT1, OUT4		0.15	
		0.5s max OUT0		2.5	
		Logic "LOW", sink current, continuous; $V_{OUT} \leq 0.4V$		0.05	
		Logic "HIGH", source current; external load to GND; $V_{OUT} \geq 2.0V$		1.5	
		Logic "HIGH", leakage current; external load to +V _{LOG} ; $V_{OUT} = V_{LOG}$ max = 40V		$V_{LOG} = 24V$	0.18
				$V_{LOG} = 48V$	0.2
				0.42	0.45
Minimum pulse width				0.5	
ESD protection - Human body model				±25	

¹ Operating temperature at higher temperatures is possible with reduced current and power ratings
² Micro 4804 can be operated in vacuum (no altitude restriction), but at altitudes over 2,500m, current and power rating are reduced due to thermal dissipation efficiency.

³ Fast loop period of 50µs is not possible with all feedback device types.

Name	First edition	Document template: P099.TQT.564.0001	Last edition	Visa:
ALN	September 2, 2024		January 14, 2025	
		Title of document	N° document	
		Micro 4804 SX4-CAN-STO Multi Axis System PRODUCT DATA SHEET	P020.103.E404.DSH.10C	Page: 3 of 5

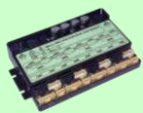

Micro 4804 SX4-CAN-STO Multi Axis System DATASHEET

P/N: P020.103.E404

Supply Output (+5V)		Min.	Typ.	Max.	Units	
Output voltage	Current sourced = 400mA ¹	5.05	5.2	5.25	V	
Output current ¹	Output voltage ≥ 4.85V			1,200	mA	
Short-circuit to GND protection		Yes / Drive resets at event				
Over-voltage protection		NOT protected				
ESD protection	Human body model	±1			KV	
Hall Inputs (Hall1, Hall2, Hall3)		Min.	Typ.	Max.	Units	
Mode compliance		TTL / CMOS / Open-collector (NPN sink), or analog (linear) 0...5V				
Default state	Input floating (Wiring disconnected)	4.5	4.8	5.2		
Input voltage	Digital	Logic "LOW"	1.5	1.7	V	
		Logic "HIGH"	3	2.5		
	Hysteresis		0.5			
	Analog	0	0.5...4.5	4.95		
Input current	Logic "LOW"; Pull to GND		2.4		mA	
	Logic "HIGH"; Internal 2.2KΩ pull-up to +5		0			
Minimum pulse width			66		µs	
ESD protection - Human body model			±15		kV	
Encoder Inputs (A1+, A1-, B1+, B1-, Z1+, Z1-, A2+, A2-, B2+, B2-) ²		Min.	Typ.	Max.	Units	
Single-ended mode compliance		TTL / CMOS / Open-collector (NPN sink)				
Single-ended threshold		A1+, B1+, Z1+, A2+, B2+	1.3	1.4	1.5	V
Single-ended input current		Input pulled to GND against on-board 2.2 KΩ pull-up to +5V		2.4	2.7	mA
Differential mode compliance		For full RS422 compliance, see ¹ TIA/EIA-422-A				
Input voltage	Hysteresis	±0.03	±0.05	±0.2	V	
	Differential mode	-15		+15		
	Common-mode range (A+ to GND, etc.)	-7		+12		
Input impedance, differential	Common-mode (A1+ to GND, etc.)		2.2		kΩ	
	Differential (A1+ to A1-, etc.)		4.4			
Input frequency	Differential mode	0		15	MHz	
Minimum pulse width	Differential mode	33			ns	
ESD protection		Human body model		±30	kV	
RS-232		Min.	Typ.	Max.	Units	
Compliance		TIA/EIA-232-C				
Bit rate	Software selectable	9600		115200	Baud	
Output voltage		±5	±5.7		V	
Short-circuit		232TX to GND Guaranteed				
Input voltage	Absolute maximum, continuous	-30		+30	V	
		Human body model		±15	kV	
Absolute encoder interface: SSI, BiSS-C, EnDAT, Tamagawa, Nikon, Sanyo Denki						
Single-ended mode		Not recommended, reduced robustness & speed				
Differential mode compliance		For full RS422 compliance, see ² TIA/EIA-422-A				
Output voltage	Differential; 50Ω differential load	1.5	3.3		V	
	Common-mode, referenced to GND	1	1.7	3		
CLOCK frequency	Nikon, Sanyo Denki	2.5, 4			MHz	
	Panasonic, Tamagawa	2.5				
	All others	1, 2, 3, 4				
Output Short-circuit protection		Common-mode voltage ±15V		Yes, protected		
DATA format	Software selectable	Binary / Gray				
		Single-turn / Multi-turn				
		Counting direction				
		CRC type				
DATA resolution	Including CRC, flags, ...		64	Bits		
	If total resolution >31 bits, some bits must be ignored by software setting to achieve a max. 31 bits resolution					

Analog Input (REF/ FDBK)		Min.	Typ.	Max.	Units
Input voltage	Operational range	0...5, -10...+10			
	Absolute maximum values, continuous	-22		+26	V
	Absolute maximum, surge (duration ≤ 1s)			±38	
Input impedance	To 1.44V				
Bandwidth (-3dB)	Software selectable	0		5.3	kHz
Resolution		12			bits
Integral linearity			±1		bits
	Offset error	Range -10V ... +10V	±3	±10	
Gain error		Range 0 ... +5V	±10	±30	%
		Range -10V ... +10V	±0.3	±0.5	
		Range 0 ... +5V	±0.5	±0.8	
ESD protection	Human body model	±1.5			kV
CAN-Bus		Min.	Typ.	Max.	Units
Compliance		CAN 2.0B, ISO 11898-2			
Software protocols compatibility		CiA301, CiA305, CiA402, TechnoCAN, TMLcan			
Bit rate	Software selectable	125, 250, 500, 1000			KBaud
Node addressing	TMlcan				-
	CANopen	SW3 selectable			1+123
Voltage	Common-mode, operating	-12		+12	V
	Common-mode, max. continuous	-58		+58	V
	Differential, max. continuous	-45		+45	V
Input impedance	Differential	40		90	KΩ
	Common-mode	20		45	KΩ
Termination resistor (120Ω)		Included – SW5			
ESD protection	Human body model	±10			kV
Safe Torque Off (STO) Inputs		Min.	Typ.	Max.	Units
Safety Integrity Level		SIL 3			
Performance Level		PL e			
Safety Category		Cat 3			
Reaction time				30	ms
Ignored diagnostic pulses	Duration			5	ms
	Repetition rate			20	Hz
MTTFd			377		years
DC			90		%
PFH			8E-10		hours
Lifetime			20		years
V _{LOS}	External power supply		SELV or PELV		
Pollution Degree	Cabinet / Housing	IP54		2	-
					-
STO wiring	Bundling / Grouping	Separate wiring for STO1, STO2			
	Shielding	Separate shield for STO1, STO2			
Compatibility	Each STO channels has separate + and - terminals	PNP (source) or NPN (sink), depending on user connection			
Isolation	Each STO channel is opto-isolated				
Voltage, STOx+ to STOx-	Inactive (torque off)	0	5.6		V
	Active (motor driven)	18	24		V
	Abs. maximum, continuous	-70		+70	V
Voltage	Isolation, STO1 to STO2	±2			KV
	Isolation, STOx to GND	±2			KV
Current	STOx+ - STOx- = 24V	3	5		mA
ESD protection	Human body model	±30			kV

[†] Stresses beyond values listed under "absolute maximum ratings" may cause permanent damage to the device. Exposure to absolute-maximum-rated conditions for extended periods may affect device reliability.

¹ Specified currents are intended per drive. Each drive has separate +5V outputs

² To achieve full RS-422 compatibility and enhance noise rejection, it is necessary to connect an 120Ω resistor across each signal pair (A1+/A1-, B1+/B1-, Z1+/Z1-, A2+/A2-, B2+/B2-). This can be done through SW1 and SW2.

Name ALN	First edition September 2, 2024	Document template: P099.TQT.564.0001	Last edition January 14, 2025	Visa:
TECHNO SOFT		Title of document Micro 4804 SX4-CAN-STO Multi Axis System PRODUCT DATA SHEET	N° document P020.103.E404.DSH.10C	Page: 4 of 5

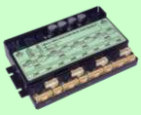

Micro 4804 SX

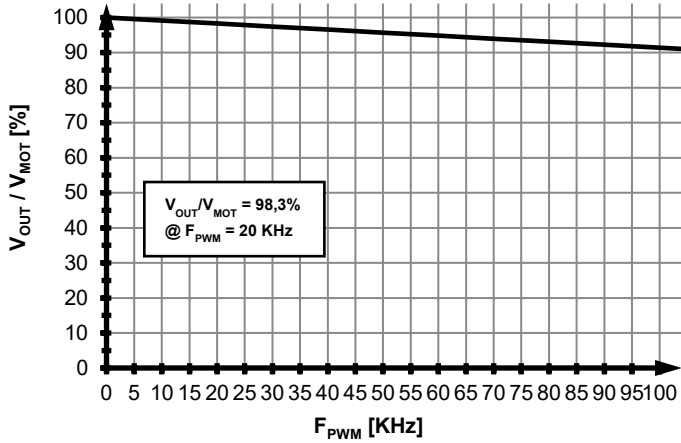

Micro 4804 SX

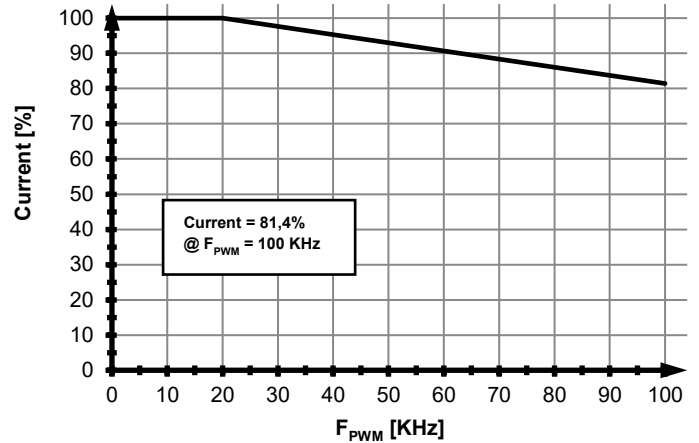

Micro 4804 SX

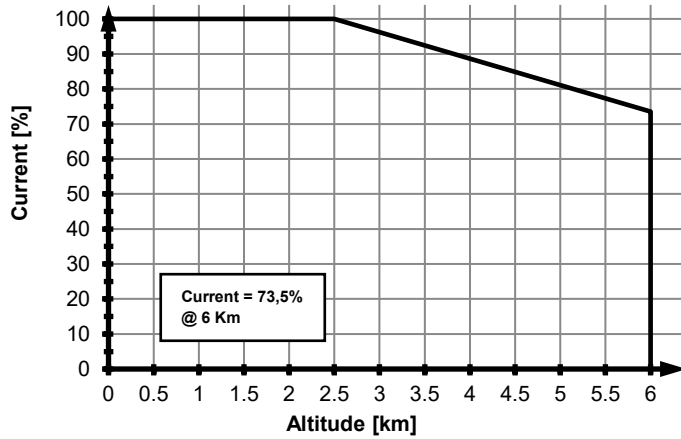

Micro 4804 SX

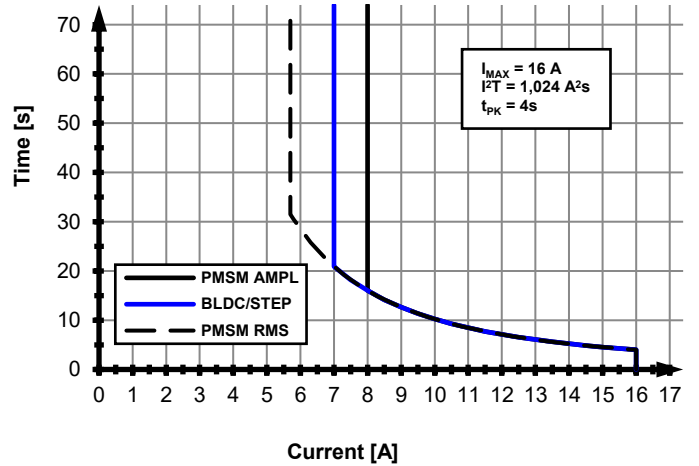

Micro 4804 SX

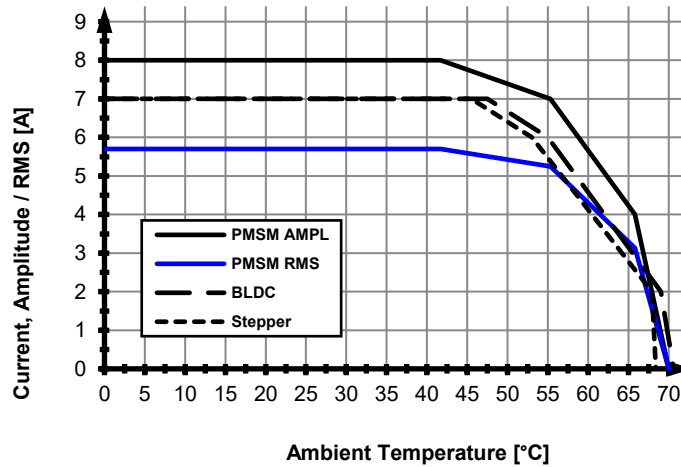

Name ALN	First edition September 2, 2024	Document template: P099.TQT.564.0001	Last edition January 14, 2025	Visa:	
TECHNO SOFT		Title of document Micro 4804 SX4-CAN-STO Multi Axis System PRODUCT DATA SHEET	N° document P020.103.E404.DSH.10C Page: 5 of 5		