

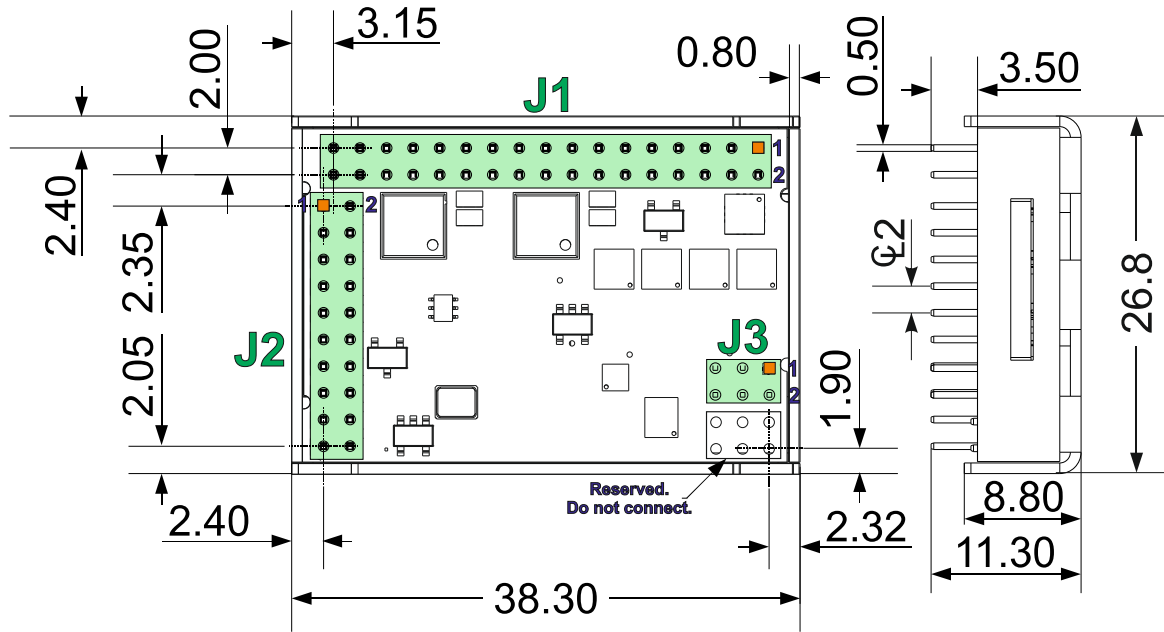

Micro 4804 PZ-CAT DATASHEET

P/N: P020.002.E322



All dimensions are in mm. Drawing not to scale. Pins facing upward view.

Motor – sensor configurations					
Sensor	Motor				
	PMSM	BLDC	DC BRUSH	STEP (2-ph)	STEP (3-ph)
Incr. Encoder	Ⓢ		Ⓢ	Ⓢ	
Incr. Encoder + Dig. Hall	Ⓢ	Ⓢ			
Linear Halls	Ⓢ				
Digital Hall control only	Ⓢ				
BISS / SSI / EnDAT / TAMAGAWA / Nikon / Sanyo Denki / Panasonic	Ⓢ	Ⓢ	Ⓢ	Ⓢ	
Tacho			Ⓢ		
Open-loop (no sensor)				Ⓢ	Ⓢ

Mating Connectors			
Producer	Part No.	Connector	Description
Samtec	SQW-117-01-F-D(-VS)	J1	2x17, 2.0mm THT (SMD) socket
	CLT-117-02-F-D		2x17, 2.0mm SMD pass-through socket
	SQW-110-01-F-D(-VS)	J2	2x10, 2.0mm THT (SMD) socket
	CLT-110-02-F-D		2x10, 2.0mm SMD pass-through socket
	SQW-103-01-F-D(-VS)	J3	2x3, 2.0mm THT (SMD) socket
	CLT-103-02-F-D		2x3, 2.0mm SMD pass-through socket

- **Features**
- Motion controller and drive in a single compact unit based on MotionChip™ technology
- Universal solution for control of rotary and linear brushless, brushed and 2 or 3-phase step motors
- Advanced motion control features, including CSP, CSV, CST, PVT, S-curve, electronic gearing, camming, and more.
- Motor supply: 48V nominal
- Motor output current:
 - Nominal: 5.7A_{RMS} / 8A amplitude for PMSM motors
7A for DC / BLDC / Step motors
 - Peak: 11.3A_{RMS} / 16A amplitude
- Logic supply: 24V nominal, 48V max
- Feedback Options:
 - 1 x Hall sensor interface (digital or linear)
 - Feedback#1 and Feedback#2 can be:
 - Incremental encoder A / B (index Z only for Feedback 1): differential or single-ended;
 - Absolute encoder: differential or single-ended. Supported protocols: SSI, BiSS, EnDAT, Tamagawa, Panasonic, Nikon, Sanyo Denki.
- 1 x analogue input, 12-bit, software selectable: 0-5V or ±10V; Reference, Feedback or General purpose
- 3 x digital inputs: 2 for limit switches + one Enable, NPN, pull-up on-board to +5V. Pull to GND to activate.
- 3 x configurable I/Os, each software selectable as:
 - Digital input, NPN, with pull-up on-board to +5V. Pull to GND to activate;
 - Digital output, NPN (open-collector), with pull-up on-board to +5V. Sink current: 1 x 1.5A to drive inductive loads (such as mechanical brake), 2 x 0.1A.
- Commissioning (set-up) possible through RS232, USB, FoE (file-over-EtherCAT) or EoE (Ethernet-over-EtherCAT)
- EtherCAT connection to standard RJ45: requires external magnetics (may be integrated into RJ45)
- 24Kwords E²ROM to store setup data, TML motion programs, cam tables and other user data
- 16Kwords SRAM memory for data acquisition
- Operating ambient temperature: 0-40°C (over 40°C with de-rating)
- Programmable protections: any short-circuit between motor phases, GND and/or supply, over/under-voltage, over-current, I²t drive & motor, control error
- 3 AxisID inputs, for hardware-based address setting
- >98% voltage efficiency, >98% power efficiency

Name ALN	First edition July 17, 2024	Document template: P099.TQT.564.0001	Last edition January 14, 2025	Visa:
TECHNOSOFT		Title of document Micro 4804 PZ-CAT PRODUCT DATA SHEET	N° document P020.002.E322.DSH.10D	Page: 1 of 5



Micro 4804 PZ-CAT DATASHEET P/N: P020.002.E322

Pin	Name	Type	Description
1	+Vlog	I	Positive terminal of the logic supply input: 6 to 48 V _{DC}
2	A/A+	O	Phase A for 3-ph motors, A+ for 2-ph steppers, Motor+ for DC brush motors
3	GND	-	Ground return for logic supply
4	B/A-	O	Phase B for 3-ph motors, A- for 2-ph steppers, Motor- for DC brush motors
5	GND	-	Ground return for motor supply & shield for motor windings cable
6	C/B+	O	Phase C for 3-ph motors, B+ for 2-ph steppers
7	+Vmot	I	Positive terminal of the motor supply: 7 to 48 VDC
8	Cr/B-	O	Chopping resistor / Phase B- for 2-ph steppers
9	BFS	-	Boot Fail-Safe: Connect to GND to reprogram firmware in the improbable case when a power loss occurs during a firmware update and the normal firmware recovery fails
10	ID2	I	AxisID2 selection pin. See AxisID register settings table.
11	TX1-	I/O	Transmit/Receive negative, OUT port. Connect to magnetics PHY TX1 or directly to nearby RX0-
12	RX1-	I/O	Receive/Transmit negative, OUT port. Connect to magnetics PHY RX1 or directly to nearby TX0-
13	TX1+	I/O	Transmit/Receive positive, OUT port. Connect to magnetics PHY TX1 or directly to nearby RX0+
14	RX1+	I/O	Receive/Transmit positive, OUT port. Connect to magnetics PHY RX1 or directly to nearby TX0+
15	GND1*	-	Ground shield & center-tap for ECAT magnetics port 1
16	GND0*	-	Ground shield & center-tap for ECAT magnetics port 0
17	TX0-	I/O	Transmit/Receive negative, IN port. Connect to magnetics PHY TX0 or directly to nearby RX1-
18	RX0-	I/O	Receive/Transmit negative, IN port. Connect to magnetics PHY RX0 or directly to nearby TX1-
19	TX0+	I/O	Transmit/Receive positive, IN port. Connect to magnetics PHY TX0 or directly to nearby RX1+
20	RX0+	I/O	Receive/Transmit positive, IN port. Connect to magnetics PHY RX0 or directly to nearby TX1+
21	ID0	I	AxisID0 selection pin. See AxisID register settings table.
22	ID1	I	AxisID1 selection pin. See AxisID register settings table.
23	232TX	O	RS-232 Data Transmission.
24	232RX	I	RS-232 Data Reception.
25	...	Rsvd.	Reserved. Do not connect.
26			
27	IN2/LSP	I	5-48V digital NPN input. Positive limit switch input
28	IN3/LSN	I	5-48V digital NPN input. Negative limit switch input
29	IN5/Enable	I	5-48V digital NPN input. Drive Enable input
30	I/O0	I/O	5-48V 1.5A NPN (sink) general-purpose digital programmable input IN0 or output OUT0
31	I/O1	I/O	5-48V 0.1A NPN (sink) general-purpose digital programmable input IN1 or output OUT1
32	I/O4	I/O	5-48V 0.1A NPN (sink) general-purpose digital programmable input IN4 or output OUT4
33	GND	-	Ground return and shield
34	AnalogIn	I	Analog input (range software selectable 0-5V or ±10V)

* GND0, GND1, and all other GND pins are internally connected within the drive. However, it is strongly recommended to reserve GND0 and GND1 exclusively for EtherCAT-related functions, and avoid using them for any other purposes.

Pin	Name	Type	Description
1	ECAT ACT0	O	Shows the state of the physical link and activity for ECAT IN port. Active high, LV-TTL.
2	ECAT ACT1	O	Shows the state of the physical link and activity for ECAT OUT port. Active high, LV-TTL.
3	TML RDY	O	Lit after power-on when the drive initialization ends. Turned off when an error occurs. Active high, LV-TTL.
4	TML ERR	O	Turned on when the drive detects an error condition. Active high, LV-TTL.
5	ECAT RUN	O	EtherCAT® RUN indicator. Active high, LV-TTL.
6	ECAT ERR	O	EtherCAT® ERROR indicator. Active high, LV-TTL.

Pin	Name	Type	Description
1	+V USB	I	USB 5V detect input
2	GND	-	Ground return for USB
3	Hall1	I	Digital Hall, or Linear Hall sensor 1
4	Hall2	I	Digital Hall, or Linear Hall sensor 2
5	Hall3	I	Digital Hall, or Linear Hall sensor 3
6	GND	-	Ground return and shield
7	+5V	O	Supply for all feedback sensors
8	GND	-	Ground return and shield
9	EncA1+/EncA1/ Dt1+/Dt1	I	Encoder 1 A+/Data+ diff. input or single-ended input
10	EncA1-/Dt1-	I	Encoder 1 A-/Data- diff. input. Leave open for single-ended; Add externally 120Ω to pin 9 for differential
11	EncB1+/EncB1/ Clk1+/Clk1	I	Encoder 1 B+/Clock+ diff. input or single-ended input
12	EncB1-/Clk1-	I	Encoder 1 B-/Clock- diff. input. Leave open for single-ended; Add externally 120Ω to pin 11 for differential
13	EncA2+/EncA2/ Dt2+/Dt2	I	Encoder 2 A+/Data+ diff. input or single-ended input
14	EncA2-/Dt2-	I	Encoder 2 A-/Data- diff. input. Leave open for single-ended; Add externally 120Ω to pin 13 for differential
15	EncB2+/EncB2/ Clk2+/Clk2	I/O	Encoder 2 B+/Clock+ diff. input or single-ended input
16	EncB2-/Clk2-	I	Encoder 2 B-/Clock- diff. input. Leave open for single-ended; Add externally 120Ω to pin 15 for differential
17	Z1+	I	Encoder 1 Z+ diff. input or single-ended input
18	Z1-	I	Encoder 1 Z- diff. input. Leave open for single-ended; Add externally 120Ω to pin 17 for differential
19	USB DM	I/O	USB data-
20	USB DP	I/O	USB data+

MSB **AxisID register** **LSB**

Bit 8	Bit 7	Bit 6	Bit 5	Bit 4	Bit 3	Bit 2	Bit 1	Bit 0
ID2			ID1			ID0		

Nominal[V]	Minimum[V]	Maximum[V]	IDx* Bits	IDx* Value
0.000	0.00	0.53	000	0
1.06	0.53	1.41	001	1
1.76	1.41	2.01	010	2
2.25	2.01	2.43	011	3
2.60	2.43	2.75	100	4
2.89	2.75	3.01	101	5
3.13	3.01	3.22	110	6
3.32	3.22	3.30	111	7

Remarks:

1. $AxisID = (64 * ID2_Value) + (8 * ID1_Value) + ID0_Value$
 2. If all "IDx" pins are left not connected or connected to GND, the AxisID value is 255 and the EtherCAT register called "configured station alias" will be 0.
 3. Bit 8 (MSB of ID2) is ignored, and always considered as "0"
- * where "x" can be 0, 1 or 2

Name ALN	First edition July 17, 2024	Document template: P099.TQT.564.0001	Last edition January 14, 2025	Visa:
		Title of document	N° document	Page: 2 of 5
		Micro 4804 PZ-CAT PRODUCT DATA SHEET	P020.002.E322.DSH.10D	



Micro 4804 PZ-CAT DATASHEET P/N: P020.002.E322

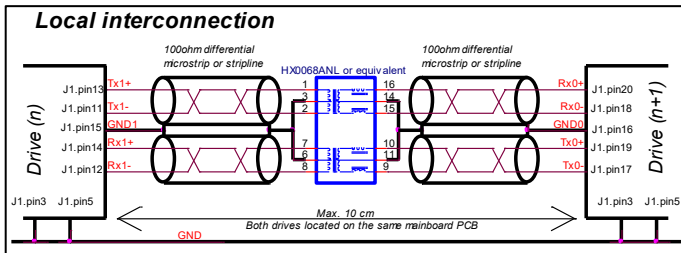
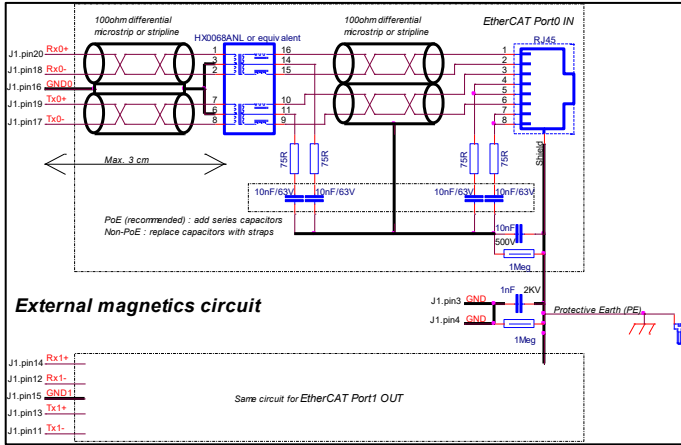

Electrical characteristics

All parameters measured under the following conditions (unless otherwise specified):

- $V_{LOG} = 24 \text{ VDC}$; $V_{MOT} = 48 \text{ VDC}$; $F_{PWM} = 20 \text{ kHz}$
- Ambient temperature = 25°C (typical values) / $0^\circ\text{C} \dots 40^\circ\text{C}$ (min/max values)
- Supplies start-up / shutdown sequence: -any-
- Load current = nominal

Operating Conditions		Min.	Typ.	Max.	Units
Ambient temperature		0		$40^{1,2}$	$^\circ\text{C}$
Ambient humidity	Non-condensing	0		90	%Rh
Altitude / pressure ³	Altitude (vs. sea level)	-0.1	0 ± 2.5	³	Km
	Ambient Pressure	0^2	0.75 ± 1	10.0	atm
Storage Conditions		Min.	Typ.	Max.	Units
Ambient temperature		-40		100	$^\circ\text{C}$
Ambient humidity	Non-condensing	0		100	%Rh
Ambient Pressure		0		10.0	atm
ESD capability (Human body model)	Not powered; applies to any accessible part			± 5	kV
	Original packaging			± 15	kV
Environmental Characteristics		Min.	Typ.	Max.	Units
Size (Length x Width x Height)	Global size	$38.3 \times 26.8 \times 11.3$			mm
		$\sim 1.5 \times 1.1 \times 0.45$			inch
Weight		22			g
Cleaning agents	Dry cleaning is recommended	Only Water- or Alcohol- based			
Protection degree	According to IEC60529	IP20			-
Power dissipation	Idle ($I_{MOT} = 0\text{A}$)		1	1.2	W
	Full power ($I_{MOT} = \text{nominal}$)		2.0	2.4	
Power efficiency	Full power ($I_{MOT} = \text{nominal}$)		98.7		%
	$f_{PWM} = 20\text{KHz}$		98.3		
Voltage efficiency	$f_{PWM} = 100\text{KHz}$		91.4		%
	Idle ($I_{MOT} = 0\text{A}$)		55		
Surface temperature ²	Idle ($I_{MOT} = 0\text{A}$)		55		$^\circ\text{C}$
	Full power ($I_{MOT} = \text{nominal}$)		100		

¹ Operating temperature at higher temperatures is possible with reduced current and power ratings
² In case of forced cooling (conduction or ventilation): a) the ambient temperature requirements may be extended substantially as long as the drive (PCB) temperature is kept below 85°C ; b) the spacing requirements can be dropped down to zero; c) the surface temperature will decrease accordingly

Mechanical Mounting		Min.	Typ.	Max.	Units
Airflow		natural convection ² , closed box			
Spacing required for horizontal mounting ²	Between adjacent drives		10		mm
	Between drives and nearby walls		10		mm
	Space needed for drive removal		20		mm
Insertion force	Between drives and roof-top		30		mm
Extraction force	Using recommended mating connectors			40	N
		8			N
Logic Supply Input (+V _{LOG})		Min	Typ.	Max.	Units
Supply voltage	Nominal values	6	24	48	V _{DC}
	Absolute maximum values, drive operating but outside guaranteed parameters	4.9		60	V _{DC}
	Absolute maximum values, continuous	-0.5		63	V _{DC}
Supply current	+V _{LOG} = 12V		90	150	mA
	+V _{LOG} = 24V		60	90	
	+V _{LOG} = 48V		45	60	
Utilization category	Acc. to 60947-4-1 ($I_{PEAK} \leq 1.05 \cdot I_{NOM}$)	DC-1			
Motor Supply Input (+V _{MOT})		Min	Typ.	Max.	Units
Supply voltage	Nominal values	7		48	V _{DC}
	Absolute maximum values, drive operating but outside guaranteed parameters	6		60	V _{DC}
	Absolute maximum values, continuous	-0.5		63	V _{DC}
Supply current	Idle		0.3		mA
	Operating		± 7	± 16	A
Voltage measurement error		± 0.15		± 0.25	V
Utilization category	Acc. to 60947-4-1 ($I_{PEAK} \leq 4.0 \cdot I_{NOM}$)	DC-3			
Supply Output (+5V)		Min.	Typ.	Max.	Units
Output voltage	Current sourced = 400mA	5.05	5.2	5.25	V
Output current	Output voltage $\geq 4.85\text{V}$			1,200	mA
Short-circuit to GND protection		Yes / Drive resets at event			
Over-voltage protection		NOT protected			
ESD protection	Human body model	± 1			KV
Motor Outputs (A/A+, B/A-, C/B+, CR/B-)		Min.	Typ.	Max.	Units
Nominal current ⁴	PMSM motors sinusoidal amplitude			± 8	A
	PMSM motors sinusoidal RMS			5.7	A _{RMS}
	DC/BLDC/STEP motors continuous			7	A
Peak current	maximum 4 seconds	-16		± 16	A
Short-circuit protection threshold			± 25	± 28	A
Short-circuit protection delay		2.6		3.5	μs
On-state voltage drop	Nominal output current; including typical mating connector contact resistance		50	70	V
	Off-state leakage current		0.3	1	mA
Current measurement	Accuracy (FS = Full Scale)		± 1	± 1.5	%FS
	Noise (current $\leq 2\text{A}$)		± 4	± 6	mA
	Noise (current $\geq 2\text{A}$)		± 30	± 50	mA
	Offset drift (compensated @ AxisOn)			± 0.16	mA/ $^\circ\text{C}$
Motor inductance (phase-to-phase)	Recommended value to avoid spurious short-circuit protection, triggered by ripple	Fast loop ⁵ V _{MOT}			μH
		50 μs 48V		133	
		100 μs 48V		266	
		50 μs 24V		66	
Motor electrical time-constant (L/R)	Recommended value for $\pm 5\%$ current measurement error	$F_{PWM} = 20 \text{ kHz}$		330	μs
		$F_{PWM} = 40 \text{ kHz}$		170	
		$F_{PWM} = 60 \text{ kHz}$		140	
		$F_{PWM} = 80 \text{ kHz}$		80	
				66	
Hall Inputs (Hall1, Hall2, Hall3)		Min.	Typ.	Max.	Units
Mode compliance	TTL / CMOS / Open-collector (NPN sink), or analog (linear) 0...5V				
Default state	Input floating (Wiring disconnected)	4.5	4.8	5.2	V
	Digital	Logic "LOW"		1.5	
Logic "HIGH"		3	2.5		
Hysteresis			0.5		
Input voltage	Analog	0	0.5...4.5	4.95	
Input current	Logic "LOW"; Pull to GND		2.4		mA
	Logic "HIGH"; Internal 2.2K Ω pull-up to +5		0		
Minimum pulse width			66		μs
ESD protection - Human body model			± 15		kV

³ Micro 4804 can be operated in vacuum (no altitude restriction), but at altitudes over 2,500m, current and power rating are reduced due to thermal dissipation efficiency.

⁴ For current values $> 4\text{A}_{RMS}$, pins J1/2...8 may need to be soldered instead of socketed, for long-term reliability - check socket manufacturer specifications.

⁵ Fast loop period of 50 μs is not possible with all feedback device types.

Name	First edition	Document template: P099.TQT.564.0001	Last edition	Visa:
ALN	July 17, 2024		January 14, 2025	
		Title of document	N° document	
		Micro 4804 PZ-CAT PRODUCT DATA SHEET	P020.002.E322.DSH.10D	
				Page: 3 of 5



Micro 4804 PZ-CAT DATASHEET P/N: P020.002.E322

Digital Inputs (IN0, IN1, IN2/LSP, IN3/LSN, IN4, IN5/ENA)	Min.	Typ.	Max.	Units
Mode compliance	NPN (sink)			
Default state	Logic HIGH			
Input voltage	Logic "LOW"	3.1	1.4	1.8
	Logic "HIGH"	0.9	2.5	1.4
	Hysteresis		1.4	1.6
	Logic "LOW"	4	3.5	
	Hysteresis		0.6	
	Floating voltage (not connected)		4.7	
	Absolute maximum, continuous	-2		+80
Input current	Logic "LOW"; Pulled to GND	6.5	8	mA
	Logic "HIGH"; Pulled to +24V	0.2	0.4	
Input frequency	0		500	kHz
Minimum pulse	1			µs
ESD protection - Human body model	±2			kV
Digital Outputs (OUT0, OUT1, OUT4)	Min.	Typ.	Max.	Units
Mode compliance	NPN (sink) 24V			
Load type	Resistive, Inductive			
Default state	Not supplied (+V _{LOG} floating)			
Output voltage	Immediately after power-up	High-Z (floating)		
	Logic "LOW"; output current = 1.5A for OUT0/0.05A for OUT1, OUT4			0.4
	Logic "HIGH"; output current = 0, no load	4	4.7	5.2
	Logic "HIGH", external load to +V _{LOG}		V _{LOG}	
	Absolute maximum, continuous (free-wheeling diodes to +V _{LOG} to GND)	-0.5		V _{LOG} +0.5
Output current	Absolute maximum, surge (duration ≤ 1s) †	-1		V _{LOG} +1
	Logic "LOW", sink current, short duration, duty cycle ≤ 1%	5s max		0.1
		0.5s max		0.15
	Logic "LOW", sink current, continuous; V _{OUT} ≤ 0.4V	OUT1, OUT4		0.05
		OUT0		1.5
	Logic "HIGH", source current; external load to GND; V _{OUT} ≥ 2.0V			5
Logic "HIGH", leakage current; external load to +V _{LOG} ; V _{OUT} = V _{LOG} max = 40V	V _{LOG} =24V	0.18	0.2	
	V _{LOG} =48V	0.42	0.45	
Minimum pulse width	0.5			µs
ESD protection - Human body model	±25			kV
Encoder Inputs (A1+, A1-, B1+, B1-, Z1+, Z1-, A2+, A2-, B2+, B2-)	Min.	Typ.	Max.	Units
Single-ended mode compliance	Leave A1-, B1-, Z1-, A2-, B2- floating			
Single-ended threshold	A1+, B1+, Z1+, A2+, B2+	1.3	1.4	1.5
Single-ended input current	Input pulled to GND against on-board 2.2 KΩ pull-up to +5V		2.4	2.7
Differential mode compliance	For full RS422 compliance, see ¹			
Input voltage	Hysteresis	±0.03	±0.05	±0.2
	Differential mode	-15		+15
	Common-mode range (A+ to GND, etc.)	-7		+12
Input impedance, differential	Common-mode (A1+ to GND, etc.)		2.2	kΩ
Input frequency	Differential mode	0		15
Minimum pulse width	Differential mode	33		ns
ESD protection	Human body model	±30		kV
RS-232	Min.	Typ.	Max.	Units
Compliance	TIA/EIA-232-C			
Bit rate	Software selectable	9600		115200
Output voltage		±5	±5.7	V
Short-circuit	232TX to GND	Guaranteed		
Input voltage	Absolute maximum, continuous	-30		+30
ESD protection	Human body model	±15		kV

EtherCAT®	Min.	Typ.	Max.	Units
Compliance	IEEE802.3, IEC61158			
Software protocols compatibility	CoE, FoE, EoE, IEC61800-7-301			
Magnetics	Turns ratio	1:1		
	Inductance	350		µH
	Common mode rejection	-30		dB
	Center tap	to J1 pins 15, 16		
	Transmission line	According to TIA/EIA-568-5-A	5	5e
Auto	swap + / - inside a pair	Yes (MLT3 encoding)		
	swap Rx / Tx pairs	Yes (auto-MDI/MDIX)		
	Swap port0(IN) / port1(OUT)	NO (EtherCAT requirement)		
Configured Station Alias (using AxisID)	0 + 255			-
ESD protection	Human body model	±5		kV
Absolute encoder interface: SSI, BiSS-C, EnDAT, Tamagawa, Nikon, Sanyo Denki	Min.	Typ.	Max.	Units
Single-ended mode	Not recommended, reduced robustness & speed			
Differential mode compliance	For full RS422 compliance, see ¹		TIA/EIA-422-A	
Output voltage	Differential; 50Ω differential load	1.5	3.3	
	Common-mode, referenced to GND	1	1.7	3
CLOCK frequency	Nikon, Sanyo Denki	2.5, 4		
	Panasonic, Tamagawa	2.5		
	All others	1, 2, 3, 4		
Output Short-circuit protection	Common-mode voltage ±15V		Yes, protected	
DATA format	Software selectable	Binary / Gray		
		Single-turn / Multi-turn		
		Counting direction		
		CRC type		
DATA resolution	Including CRC, flags, ...		64	Bits
If total resolution >31 bits, some bits must be ignored by software setting to achieve a max. 31 bits resolution				
Analog Input (REF / FDBK)	Min.	Typ.	Max.	Units
Input voltage	Operational range	0...-5, -10...+10		
	Absolute maximum values, continuous	-22		+26
	Absolute maximum, surge (duration ≤ 1s)			±38
Input impedance	To 1.44V	20		kΩ
Bandwidth (-3dB)	Software selectable	0		5.3
Resolution		12		
Integral linearity			±1	bits
Offset error	Range -10V ... +10V		±3	±10
	Range 0 ... +5V		±10	±30
Gain error	Range -10V ... +10V		±0.3	±0.5
	Range 0 ... +5V		±0.5	±0.8
ESD protection	Human body model	±1.5		kV
AxisID inputs	Min.	Typ.	Max.	Units
Default state	ID1, ID1, ID2 floating	Configured Station Alias = 0, AxisID=255		
Internal pull-down to GND		95	100	105
ESD protection	Human body model	±250		V
LED outputs	Min.	Typ.	Max.	Units
Polarity	Active high (high=LED lit)			
	Common cathode to GND			
Voltage	I _{OH} ≤ 0.9mA	2.9	3.3	V
	I _{OH} ≤ 1.5mA	2.4		V
	I _{OL} ≤ 2.0mA		0	0.4
	Abs. max., continuous	-0.5		3.8
Current	Sink (I _{OL}) current larger than source (I _{OH}) current	-2.0		+1.5
Short-circuit protection	NOT protected			
ESD protection	Human body model	±250		V
BFS input	Min.	Typ.	Max.	Units
Polarity	Active Low (0=fail-safe boot, 1=normal)			
Default state	BFS floating		High	
Voltage	Logic low (active)		0	1.1
	Logic high (inactive)	2.0	3.3	
	Abs. max., continuous	-0.5		3.8
Current	Logic low (2.2KΩ pull to +3.3V)		1.5	1.6
	Logic high		0	
ESD protection	Human body model	±250		V

† Stresses beyond values listed under "absolute maximum ratings" may cause permanent damage to the device. Exposure to absolute-maximum-rated conditions for extended periods may affect device reliability.

¹ Full RS-422 compatibility, as well as noise rejection improvement requires an external 120Ω resistor connected across each signal pair (A1+/A1-, B1+/B1-, Z1+/Z1-, A2+/A2-, B2+/B2-)

Name ALN	First edition July 17, 2024	Document template: P099.TQT.564.0001	Last edition January 14, 2025	Visa:
TECHNOSOFT		Title of document Micro 4804 PZ-CAT PRODUCT DATA SHEET	N° document P020.002.E322.DSH.10D	
Page: 4 of 5				



Micro 4804 PZ

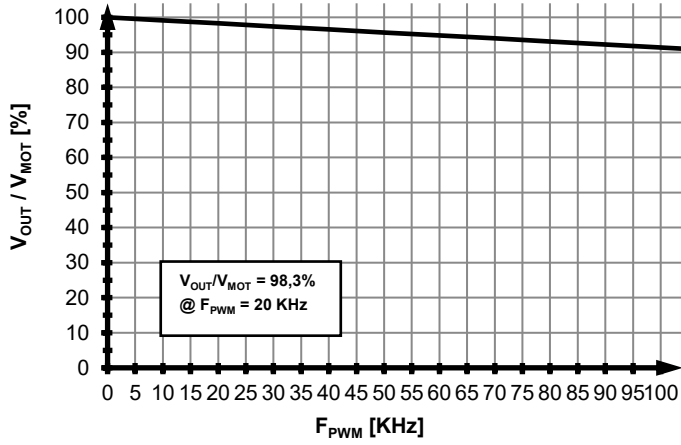

Micro 4804 PZ

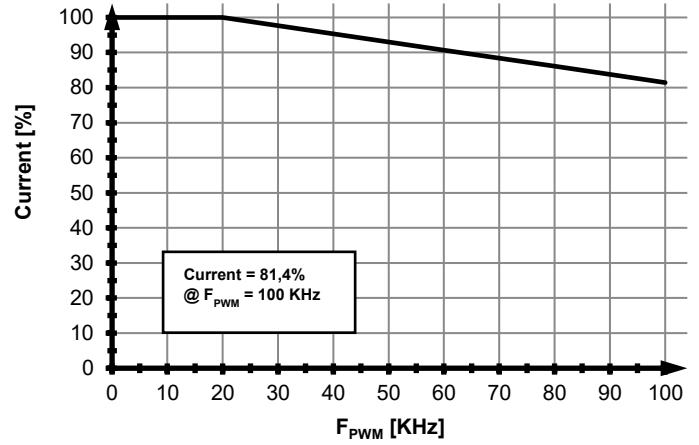

Micro 4804 PZ

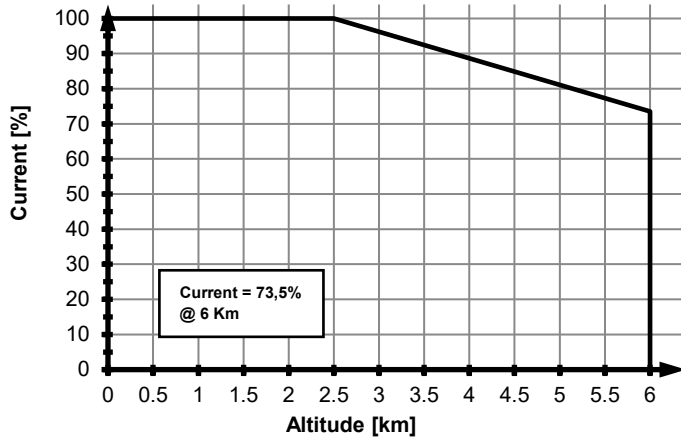

Micro 4804 PZ

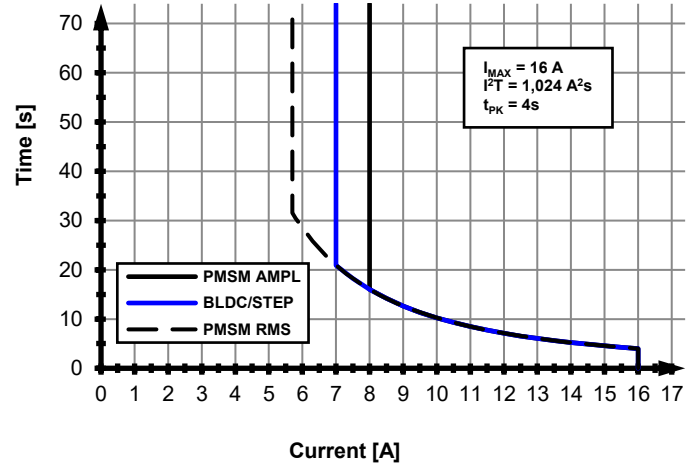

Micro 4804 PZ

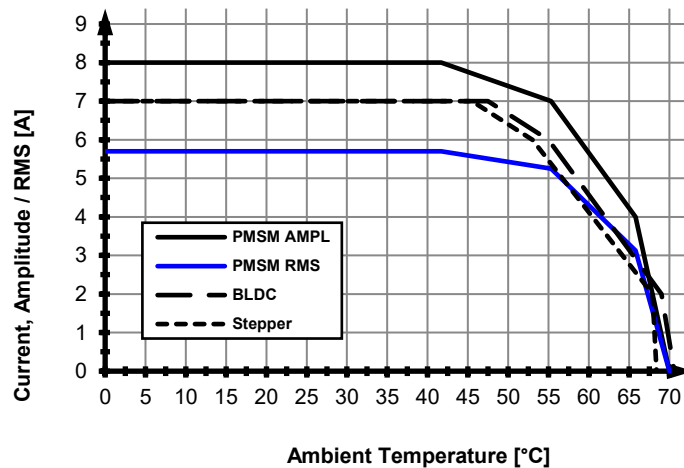

Name ALN	First edition July 17, 2024	Document template: P099.TQT.564.0001	Last edition January 14, 2025	Visa:
		Title of document Micro 4804 PZ-CAT PRODUCT DATA SHEET	N° document P020.002.E322.DSH.10D	
			Page: 5 of 5	