

All dimensions are in mm. Drawing not to scale. Pins facing downward view.

Motor – sensor configurations					
Sensor	Motor				
	PMSM	BLDC	DC BRUSH	STEP (2-ph)	STEP (3-ph)
Incr. Encoder	Ⓢ		Ⓢ	Ⓢ	
Incr. Encoder + Dig. Hall	Ⓢ	Ⓢ			
Linear Halls	Ⓢ				
Digital Hall control only	Ⓢ				
BISS / SSI / EnDAT / TAMAGAWA / Nikon / Sanyo Denki / Panasonic	Ⓢ	Ⓢ	Ⓢ	Ⓢ	
Tacho			Ⓢ		
Open-loop (no sensor)				Ⓢ	Ⓢ

Mating Connectors			
Producer	Part No.	Connector	Description
Samtec	SQW-117-01-F-D(-VS)	J1	2x17, 2.0mm THT (SMD) socket
	CLT-117-02-F-D		2x17, 2.0mm SMD pass-through socket
	SQW-110-01-F-D(-VS)	J2	2x10, 2.0mm THT (SMD) socket
	CLT-110-02-F-D		2x10, 2.0mm SMD pass-through socket
	SQW-103-01-F-D(-VS)	J3	2x3, 2.0mm THT (SMD) socket
	CLT-103-02-F-D		2x3, 2.0mm SMD pass-through socket

- **Features**
- Motion controller and drive in a single compact unit based on MotionChip™ technology
- Universal solution for control of rotary and linear brushless, brushed and 2 or 3-phase step motors
- Advanced motion control features, including CSP, CSV, CST, PVT, S-curve, electronic gearing, camming, and more.
- Motor supply: 48V nominal
- Motor output current:
 - Nominal: 4.5A_{RMS} / 6.3A amplitude for PMSM motors
 - 5.5A for DC / BLDC / Step motors
 - Peak: 11.3A_{RMS} / 16A amplitude
- Logic supply: 24V nominal, 48V max
- Feedback Options:
 - 1 x Hall sensor interface (digital or linear)
 - Feedback#1 and Feedback#2 can be:
 - Incremental encoder A / B (index Z only for Feedback 1): differential or single-ended;
 - Absolute encoder: differential or single-ended. Supported protocols: SSI, BiSS, EnDAT, Tamagawa, Panasonic, Nikon, Sanyo Denki.
- 1 x analogue input, 12-bit, software selectable: 0-5V or ±10V; Reference, Feedback or General purpose
- 3 x digital inputs: 2 for limit switches + one Enable, NPN, pull-up on-board to +5V. Pull to GND to activate.
- 3 x configurable I/Os, each software selectable as:
 - Digital input, NPN, with pull-up on-board to +5V. Pull to GND to activate;
 - Digital output, NPN (open-collector), with pull-up on-board to +5V. Sink current: 1 x 1.5A to drive inductive loads (such as mechanical brake), 2 x 0.1A.
- Commissioning (set-up) possible through RS232, USB, FoE (file-over-EtherCAT) or EoE (Ethernet-over-EtherCAT)
- EtherCAT connection to standard RJ45: requires external magnetics (may be integrated into RJ45)
- 24Kwords E²ROM to store setup data, TML motion programs, cam tables and other user data
- 16Kwords SRAM memory for data acquisition
- Operating ambient temperature: 0-40°C (over 40°C with de-rating)
- Programmable protections: any short-circuit between motor phases, GND and/or supply, over/under-voltage, over-current, I²t drive & motor, control error
- 3 AxisID inputs, for hardware-based address setting
- >98% voltage efficiency, >98% power efficiency

Name ALN	First edition November 3, 2023	Document template: P099.TQT.564.0001	Last edition October 18, 2024	Visa:
		Title of document Micro 4804 MZ-CAT PRODUCT DATA SHEET	N° document P020.002.E122.DSH.10D	Page: 1 of 5



Micro 4804 MZ-CAT DATASHEET

P/N: P020.002.E122

Pin	Name	Type	Description
1	+Vlog	I	Positive terminal of the logic supply input: 6 to 48 V _{DC}
2	A/A+	O	Phase A for 3-ph motors, A+ for 2-ph steppers, Motor+ for DC brush motors
3	GND	-	Ground return for logic supply
4	B/A-	O	Phase B for 3-ph motors, A- for 2-ph steppers, Motor- for DC brush motors
5	GND	-	Ground return for motor supply & shield for motor windings cable
6	C/B+	O	Phase C for 3-ph motors, B+ for 2-ph steppers
7	+Vmot	I	Positive terminal of the motor supply: 7 to 48 VDC
8	Cr/B-	O	Chopping resistor / Phase B- for 2-ph steppers
9	BFS	-	Boot Fail-Safe: Connect to GND to reprogram firmware in the improbable case when a power loss occurs during a firmware update and the normal firmware recovery fails
10	ID2	I	AxisID2 selection pin. See AxisID register settings table.
11	TX1-	I/O	Transmit/Receive negative, OUT port. Connect to magnetics PHY TX1 or directly to nearby RX0-
12	RX1-	I/O	Receive/Transmit negative, OUT port. Connect to magnetics PHY RX1 or directly to nearby TX0-
13	TX1+	I/O	Transmit/Receive positive, OUT port. Connect to magnetics PHY TX1 or directly to nearby RX0+
14	RX1+	I/O	Receive/Transmit positive, OUT port. Connect to magnetics PHY RX1 or directly to nearby TX0+
15	GND1*	-	Ground shield & center-tap for ECAT magnetics port 1
16	GND0*	-	Ground shield & center-tap for ECAT magnetics port 0
17	TX0-	I/O	Transmit/Receive negative, IN port. Connect to magnetics PHY TX0 or directly to nearby RX1-
18	RX0-	I/O	Receive/Transmit negative, IN port. Connect to magnetics PHY RX0 or directly to nearby TX1-
19	TX0+	I/O	Transmit/Receive positive, IN port. Connect to magnetics PHY TX0 or directly to nearby RX1+
20	RX0+	I/O	Receive/Transmit positive, IN port. Connect to magnetics PHY RX0 or directly to nearby TX1+
21	ID0	I	AxisID0 selection pin. See AxisID register settings table.
22	ID1	I	AxisID1 selection pin. See AxisID register settings table.
23	232TX	O	RS-232 Data Transmission.
24	232RX	I	RS-232 Data Reception.
25	...	Rsvd.	Reserved. Do not connect.
26			
27	IN2/LSP	I	5-48V digital NPN input. Positive limit switch input
28	IN3/LSN	I	5-48V digital NPN input. Negative limit switch input
29	IN5/Enable	I	5-48V digital NPN input. Drive Enable input
30	I/O0	I/O	5-48V 1.5A NPN (sink) general-purpose digital programmable input IN0 or output OUT0
31	I/O1	I/O	5-48V 0.1A NPN (sink) general-purpose digital programmable input IN1 or output OUT1
32	I/O4	I/O	5-48V 0.1A NPN (sink) general-purpose digital programmable input IN4 or output OUT4
33	GND	-	Ground return and shield
34	AnalogIn	I	Analog input (range software selectable 0-5V or ±10V)

* GND0, GND1, and all other GND pins are internally connected within the drive. However, it is strongly recommended to reserve GND0 and GND1 exclusively for EtherCAT-related functions, and avoid using them for any other purposes.

Pin	Name	Type	Description
1	ECAT ACT0	O	Shows the state of the physical link and activity for ECAT IN port. Active high, LV-TTL.
2	ECAT ACT1	O	Shows the state of the physical link and activity for ECAT OUT port. Active high, LV-TTL.
3	TML RDY	O	Lit after power-on when the drive initialization ends. Turned off when an error occurs. Active high, LV-TTL.
4	TML ERR	O	Turned on when the drive detects an error condition. Active high, LV-TTL.
5	ECAT RUN	O	EtherCAT® RUN indicator. Active high, LV-TTL.
6	ECAT ERR	O	EtherCAT® ERROR indicator. Active high, LV-TTL.

Pin	Name	Type	Description
1	+V USB	I	USB 5V detect input
2	GND	-	Ground return for USB
3	Hall1	I	Digital Hall, or Linear Hall sensor 1
4	Hall2	I	Digital Hall, or Linear Hall sensor 2
5	Hall3	I	Digital Hall, or Linear Hall sensor 3
6	GND	-	Ground return and shield
7	+5V	O	Supply for all feedback sensors
8	GND	-	Ground return and shield
9	EncA1+/EncA1/ Dt1+/Dt1	I	Encoder 1 A+/Data+ diff. input or single-ended input
10	EncA1-/Dt1-	I	Encoder 1 A-/Data- diff. input. Leave open for single-ended; Add externally 120Ω to pin 9 for differential
11	EncB1+/EncB1/ Clk1+/Clk1	I	Encoder 1 B+/Clock+ diff. input or single-ended input
12	EncB1/ Clk1-	I	Encoder 1 B-/Clock- diff. input. Leave open for single-ended; Add externally 120Ω to pin 11 for differential
13	EncA2+/EncA2/ Dt2+/Dt2	I	Encoder 2 A+/Data+ diff. input or single-ended input
14	EncA2-/Dt2-	I	Encoder 2 A-/Data- diff. input. Leave open for single-ended; Add externally 120Ω to pin 13 for differential
15	EncB2+/EncB2/ Clk2+/Clk2	I/O	Encoder 2 B+/Clock+ diff. input or single-ended input
16	EncB2-/ Clk2-	I	Encoder 2 B-/Clock- diff. input. Leave open for single-ended; Add externally 120Ω to pin 15 for differential
17	Z1+	I	Encoder 1 Z+ diff. input or single-ended input
18	Z1-	I	Encoder 1 Z- diff. input. Leave open for single-ended; Add externally 120Ω to pin 17 for differential
19	USB DM	I/O	USB data-
20	USB DP	I/O	USB data+

No.	Name	Color	Description
LED1	TML ERR	RED	Turned on when the drive detects an error condition.
LED2	ECAT ACT1	YELLOW	Shows the state of the physical link and activity for ECAT OUT port.
LED3	TML RDY	GREEN	Lit after power-on when the drive initialization ends. Turned off when an error occurs.
LED4	ECAT ERR	RED	EtherCAT® ERROR indicator.
LED5	ECAT ACT0	YELLOW	Shows the state of the physical link and activity for ECAT IN port.
LED6	ECAT RUN	GREEN	EtherCAT® RUN indicator.

AxisID register										
MSB	Bit 8	Bit 7	Bit 6	Bit 5	Bit 4	Bit 3	Bit 2	Bit 1	Bit 0	LSB
ID2			ID1			ID0				
Nominal[V]	Minimum[V]	Maximum[V]	IDx* Bits	IDx* Value						
0.000	0.00	0.53	000	0						
1.06	0.53	1.41	001	1						
1.76	1.41	2.01	010	2						
2.25	2.01	2.43	011	3						
2.60	2.43	2.75	100	4						
2.89	2.75	3.01	101	5						
3.13	3.01	3.22	110	6						
3.32	3.22	3.30	111	7						

Remarks:
1. $AxisID = (64 * ID2_Value) + (8 * ID1_Value) + ID0_Value$
2. If all "IDx" pins are left not connected or connected to GND, the AxisID value is 255 and the EtherCAT register called "configured station alias" will be 0.
3. Bit 8 (MSB of ID2) is ignored, and always considered as "0"
* where "x" can be 0, 1 or 2

Name ALN	First edition November 3, 2023	Document template: P099.TQT.564.0001	Last edition October 18, 2024	Visa:
		Title of document Micro 4804 MZ-CAT PRODUCT DATA SHEET	N° document P020.002.E122.DSH.10D	Page: 2 of 5



Micro 4804 MZ-CAT DATASHEET P/N: P020.002.E122

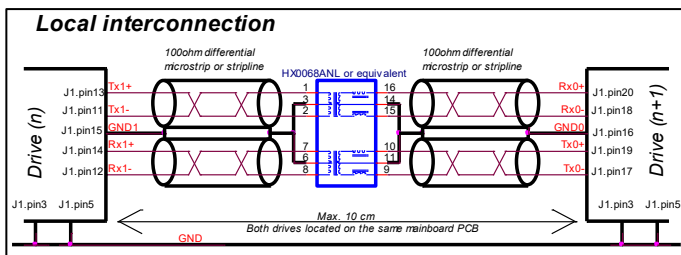
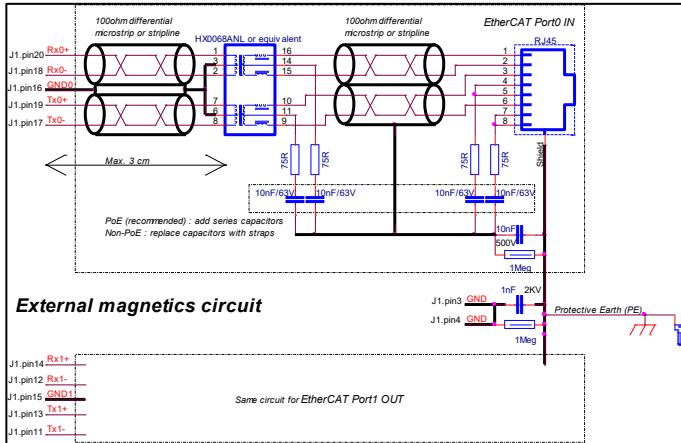

Electrical characteristics

All parameters measured under the following conditions (unless otherwise specified):

- $V_{LOG} = 24$ VDC; $V_{MOT} = 48$ VDC; $F_{PWM} = 20$ kHz
- Ambient temperature = 25°C (typical values) / 0°C...40°C (min/max values)
- Supplies start-up / shutdown sequence: -any-
- Load current = nominal

Operating Conditions		Min.	Typ.	Max.	Units
Ambient temperature		0		40 ^{1,2}	°C
Ambient humidity	Non-condensing	0		90	%Rh
Altitude / pressure ³	Altitude (vs. sea level)	-0.1	0 + 2.5		Km
	Ambient Pressure	0 ²	0.75 ± 1	10.0	atm
Storage Conditions		Min.	Typ.	Max.	Units
Ambient temperature		-40		100	°C
Ambient humidity	Non-condensing	0		100	%Rh
Ambient Pressure		0		10.0	atm
ESD capability (Human body model)	Not powered; applies to any accessible part			±0.5	kV
	Original packaging			±15	kV
Environmental Characteristics		Min.	Typ.	Max.	Units
Size (Length x Width x Height)	Global size	38.1 x 25 x 9.6			mm
		~1.5 x 1 x 0.4			inch
Weight		8			g
Cleaning agents	Dry cleaning is recommended	Only Water- or Alcohol- based			
Protection degree	According to IEC60529	IP20			-
Power dissipation	Idle ($I_{MOT} = 0A$)		1	1.2	W
	Full power ($I_{MOT} = \text{nominal}$)		2.0	2.4	
Power efficiency	Full power ($I_{MOT} = \text{nominal}$)		98.7		%
	$f_{PWM} = 20KHz$		98.3		
Voltage efficiency	$f_{PWM} = 100KHz$		91.4		%
	Idle ($I_{MOT} = 0A$)		55		
Surface temperature ²	Full power ($I_{MOT} = \text{nominal}$)			100	°C

¹ Operating temperature at higher temperatures is possible with reduced current and power ratings
² In case of forced cooling (conduction or ventilation): a) the ambient temperature requirements may be extended substantially as long as the drive (PCB) temperature is kept below 85°C; b) the spacing requirements can be dropped down to zero; c) the surface temperature will decrease accordingly

Mechanical Mounting		Min.	Typ.	Max.	Units
Airflow		natural convection ² , closed box			
Spacing required for horizontal mounting ²	Between adjacent drives		10		mm
	Between drives and nearby walls		10		mm
	Space needed for drive removal		20		mm
	Between drives and roof-top		30		mm
Insertion force	Using recommended mating connectors			40	N
Extraction force		8			N
Logic Supply Input (+V _{LOG})		Min.	Typ.	Max.	Units
Supply voltage	Nominal values	6	24	48	V _{DC}
	Absolute maximum values, drive operating but outside guaranteed parameters	4.9		60	V _{DC}
	Absolute maximum values, continuous	-0.5		63	V _{DC}
Supply current	+V _{LOG} = 12V		90	150	mA
	+V _{LOG} = 24V		60	90	
	+V _{LOG} = 48V		45	60	
Utilization category	Acc. to 60947-4-1 ($I_{PEAK} \leq 1.05 \cdot I_{NOM}$)	DC-1			
Motor Supply Input (+V _{MOT})		Min.	Typ.	Max.	Units
Supply voltage	Nominal values	7		48	V _{DC}
	Absolute maximum values, drive operating but outside guaranteed parameters	6		60	V _{DC}
	Absolute maximum values, continuous	-0.5		63	V _{DC}
Supply current	Idle		0.3		mA
	Operating	-16	±7	+16	
Voltage measurement error		±0.15		±0.25	V
Utilization category	Acc. to 60947-4-1 ($I_{PEAK} \leq 4.0 \cdot I_{NOM}$)	DC-3			
Supply Output (+5V)		Min.	Typ.	Max.	Units
Output voltage	Current sourced = 400mA	5.05	5.2	5.25	V
Output current	Output voltage ≥ 4.85V			1,200	mA
Short-circuit to GND protection		Yes / Drive resets at event			
Over-voltage protection		NOT protected			
ESD protection	Human body model	±1			kV
Motor Outputs (A/A+, B/A-, C/B+, CR/B-)		Min.	Typ.	Max.	Units
Nominal current ⁴	PMSM motors sinusoidal amplitude			±6.3	A
	PMSM motors sinusoidal RMS			4.5	
	DC/BLDC/STEP motors continuous			5.5	
Peak current	maximum 4 seconds	-16		+16	A
Short-circuit protection threshold			±25	±28	A
Short-circuit protection delay		2.6		3.5	µs
On-state voltage drop	Nominal output current; including typical mating connector contact resistance		50	70	V
Off-state leakage current			0.3	1	mA
Current measurement	Accuracy (FS = Full Scale)		±1	±1.5	%FS
	Noise (current ≤ 2A)		±4	±6	
	Noise (current ≥ 2A)		±30	±50	
	Offset drift (compensated @ AxisOn)			±0.16	
Motor inductance (phase-to-phase)	Recommended value to avoid spurious short-circuit protection, triggered by ripple	Fast loop ⁵ V _{MOT}			µH
		50µs 48V		133	
		100µs 48V		266	
		50µs 24V		66	
Motor electrical time-constant (L/R)	Recommended value for ±5% current measurement error	F _{PWM} = 20 kHz		330	µs
		F _{PWM} = 40 kHz		170	
		F _{PWM} = 60 kHz		140	
		F _{PWM} = 80 kHz		80	
				66	
Hall Inputs (Hall1, Hall2, Hall3)		Min.	Typ.	Max.	Units
Mode compliance	TTL / CMOS / Open-collector (NPN sink), or analog (linear) 0...5V				
Default state	Input floating (Wiring disconnected)	4.5	4.8	5.2	V
	Digital	Logic "LOW"		1.5	
Logic "HIGH"		3	2.5		
Hysteresis			0.5		
Input voltage	Analog	0	0.5...4.5	4.95	
Input current	Logic "LOW"; Pull to GND		2.4		mA
	Logic "HIGH"; Internal 2.2KΩ pull-up to +5		0		
Minimum pulse width			66		µs
ESD protection - Human body model			±15		kV

³ Micro 4804 can be operated in vacuum (no altitude restriction), but at altitudes over 2,500m, current and power rating are reduced due to thermal dissipation efficiency.

⁴ For current values >4A_{RMS}, pins J1/2...8 may need to be soldered instead of socketed, for long-term reliability - check socket manufacturer specifications.

⁵ Fast loop period of 50µs is not possible with all feedback device types.

Name	First edition	Document template: P099.TQT.564.0001	Last edition	Visa:
ALN	November 3, 2023		October 18, 2024	
		Title of document	N° document	
		Micro 4804 MZ-CAT	P020.002.E122.DSH.10D	
PRODUCT DATA SHEET			Page: 3 of 5	



Micro 4804 MZ-CAT DATASHEET P/N: P020.002.E122

Digital Inputs (IN0, IN1, IN2/LSP, IN3/LSN, IN4, IN5/ENA)		Min.	Typ.	Max.	Units
Mode compliance		NPN (sink)			
Default state		Logic HIGH			
Input voltage	Logic "LOW"		1.4	1.8	V
	Logic "HIGH"		3.1	2.5	
	Hysteresis		0.9	1.1	
	Logic "LOW"			1.4	
	Logic "HIGH"			1.6	
	Hysteresis			0.6	
	Floating voltage (not connected)			4.7	
Input current	Absolute maximum, continuous			+80	mA
	Logic "LOW"; Pulled to GND		6.5	8	
Input frequency	Logic "HIGH"; Pulled to +24V		0.2	0.4	
Minimum pulse		0		500	kHz
ESD protection - Human body model		±2			kV
Digital Outputs (OUT0, OUT1, OUT4)		Min.	Typ.	Max.	Units
Mode compliance		NPN (sink) 24V			
Load type		Resistive, Inductive			
Default state		High-Z (floating)			
Immediately after power-up		Logic "HIGH"			
Output voltage	Logic "LOW"; output current = 1.5A for OUT0/ 0.05A for OUT1, OUT4			0.4	V
	Logic "HIGH"; output current = 0, no load	4	4.7	5.2	
	Logic "HIGH", external load to +V _{LOG}		V _{LOG}		
	Absolute maximum, continuous (free-wheeling diodes to +V _{LOG} to GND)	-0.5		V _{LOG} +0.5	
	Absolute maximum, surge (duration ≤ 1s) †	-1		V _{LOG} +1	
Output current	Logic "LOW", sink current, short duration, duty cycle ≤ 1%	5s max		0.1	A
		OUT1, OUT4		2	
	0.5s max	OUT1, OUT4		0.15	
		OUT0		2.5	
	Logic "LOW", sink current, continuous; V _{OUT} ≤ 0.4V	OUT1, OUT4		0.05	
		OUT0		1.5	
Logic "HIGH", source current; external load to GND; V _{OUT} ≥ 2.0V			5	mA	
Logic "HIGH", leakage current; external load to +V _{LOG} ; V _{OUT} = V _{LOG} max = 40V	V _{LOG} =24V		0.18	0.2	mA
	V _{LOG} =48V		0.42	0.45	
Minimum pulse width		0.5			µs
ESD protection - Human body model		±25			kV
Encoder Inputs (A1+, A1-, B1+, B1-, Z1+, Z1-, A2+, A2-, B2+, B2-) ¹		Min.	Typ.	Max.	Units
Single-ended mode compliance	Leave A1-, B1-, Z1-, A2-, B2- floating	TTL / CMOS / Open-collector (NPN sink)			
Single-ended threshold	A1+, B1+, Z1+, A2+, B2+	1.3	1.4	1.5	V
Single-ended input current	Input pulled to GND against on-board 2.2 kΩ pull-up to +5V		2.4	2.7	mA
Differential mode compliance	For full RS422 compliance, see ¹	TIA/EIA-422-A			
Input voltage	Hysteresis	±0.03	±0.05	±0.2	V
	Differential mode	-15		+15	
	Common-mode range (A+ to GND, etc.)	-7		+12	
Input impedance, differential	Common-mode (A1+ to GND, etc.)		2.2		kΩ
	Differential (A1+ to A1-, etc.)		4.4		
Input frequency	Differential mode	0		15	MHz
Minimum pulse width	Differential mode	33			ns
ESD protection	Human body model	±30			kV
RS-232		Min.	Typ.	Max.	Units
Compliance		TIA/EIA-232-C			
Bit rate	Software selectable	9600		115200	Baud
Output voltage		±5	±5.7		V
Short-circuit	232TX to GND	Guaranteed			
Input voltage	Absolute maximum, continuous	-30		+30	V
ESD protection	Human body model	±15			kV

EtherCAT®		Min.	Typ.	Max.	Units
Compliance		IEEE802.3, IEC61158			
Software protocols compatibility		CoE, FoE, EoE, IEC61800-7-301			
Magnetics		Required, external			
Turns ratio		1:1			
	Inductance	350			µH
	Common mode rejection	-30			dB
	Center tap	to J1 pins 15, 16			
Transmission line	According to TIA/EIA-568-5-A	5	5e	6	Category
	UTP	FTP	STP		Shield
Auto	swap + / - inside a pair	Yes (MLT3 encoding)			
	swap Rx / Tx pairs	Yes (auto-MDI/MDIX)			
	Swap port0(IN) / port1(OUT)	NO (EtherCAT requirement)			
Configured Station Alias (using AxisID)	0 + 255				
ESD protection	Human body model	±5			kV
Absolute encoder interface: SSI, BiSS-C, EnDAT, Tamagawa, Nikon, Sanyo Denki		Min	Typ.	Max	Units
Single-ended mode	Not recommended, reduced robustness & speed				
Differential mode compliance	For full RS422 compliance, see ¹	TIA/EIA-422-A			
Output voltage	Differential; 50Ω differential load	1.5	3.3		V
	Common-mode, referenced to GND	1	1.7	3	
CLOCK frequency	Nikon, Sanyo Denki	2.5, 4			kHz
	Panasonic, Tamagawa	2.5			
	All others	1, 2, 3, 4			
Output Short-circuit protection	Common-mode voltage ±15V	Yes, protected			
DATA format	Software selectable	Binary / Gray			
		Single-turn / Multi-turn			
		Counting direction			
		CRC type			
DATA resolution	Including CRC, flags, ...			64	Bits
	If total resolution >31 bits, some bits must be ignored by software setting to achieve a max. 31 bits resolution				
Analog Input (REF / FDBK)		Min	Typ.	Max	Units
Input voltage	Operational range	0...5, -10...+10			
	Absolute maximum values, continuous	-22		+26	V
	Absolute maximum, surge (duration ≤ 1s)			±38	
Input impedance	To 1.44V		20	kΩ	
Bandwidth (-3dB)	Software selectable	0		5.3	kHz
Resolution		12			
Integral linearity				±1	bits
Offset error	Range -10V ... +10V		±3	±10	bits
	Range 0 ... +5V		±10	±30	
	Range -10V ... +10V		±0.3	±0.5	
Gain error	Range 0 ... +5V		±0.5	±0.8	%
ESD protection	Human body model	±1.5			kV
AxisID inputs		Min.	Typ.	Max.	Units
Default state	ID1, ID1, ID2 floating	Configured Station Alias = 0, AxisID=255			
Internal pull-down to GND		95	100	105	kΩ
ESD protection	Human body model		±250		V
LED outputs		Min.	Typ.	Max.	Units
Polarity	Active high (high=LED lit)				
	Common cathode to GND				
Voltage	I _{OH} ≤ 0.9mA	2.9	3.3		V
	I _{OH} ≤ 1.5mA	2.4			V
	I _{OL} ≤ 2.0mA		0	0.4	V
Current	Abs. max., continuous	-0.5		3.8	V
	Sink (I _{OL}) current larger than source (I _{OH}) current	-2.0		+1.5	mA
Short-circuit protection	NOT protected				
ESD protection	Human body model		±250		V
BFS input		Min.	Typ.	Max.	Units
Polarity	Active Low (0=fail-safe boot, 1=normal)				
Default state	BFS floating	High			
Voltage	Logic low (active)		0	1.1	V
	Logic high (inactive)	2.0	3.3		V
	Abs. max., continuous	-0.5		3.8	V
Current	Logic low (2.2kΩ pull to +3.3V)		1.5	1.6	mA
	Logic high		0		mA
ESD protection	Human body model	±250			V

† Stresses beyond values listed under "absolute maximum ratings" may cause permanent damage to the device. Exposure to absolute-maximum-rated conditions for extended periods may affect device reliability.

¹ Full RS-422 compatibility, as well as noise rejection improvement requires an external 120Ω resistor connected across each signal pair (A1+/A1-, B1+/B1-, Z1+/Z1-, A2+/A2-, B2+/B2-)

Name	First edition	Document template: P099.TQT.564.0001	Last edition	Visa:
ALN	November 3, 2023		October 18, 2024	
		Title of document	N° document	
		Micro 4804 MZ-CAT	P020.002.E122.DSH.10D	
		PRODUCT DATA SHEET		Page: 4 of 5



Micro 4804 MZ

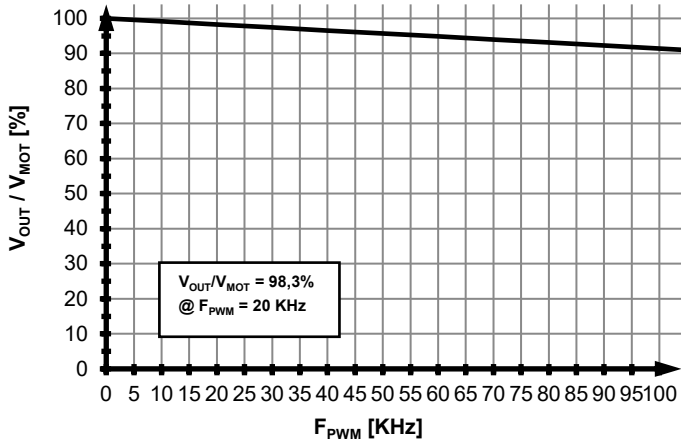

Micro 4804 MZ

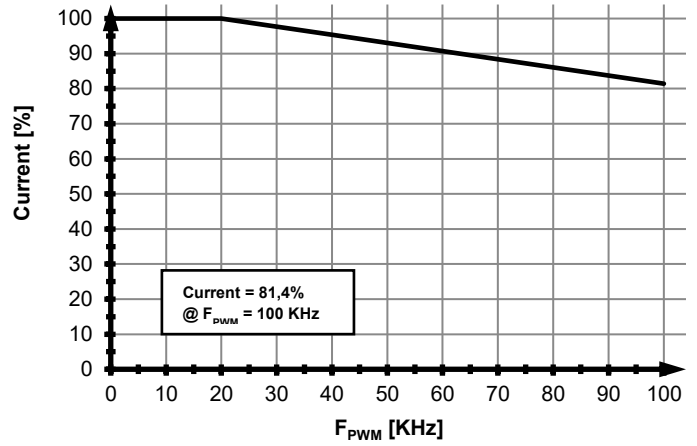

Micro 4804 MZ

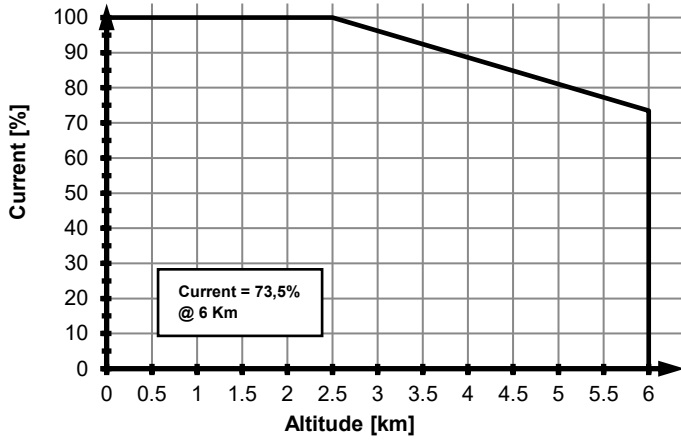

Micro 4804 MZ

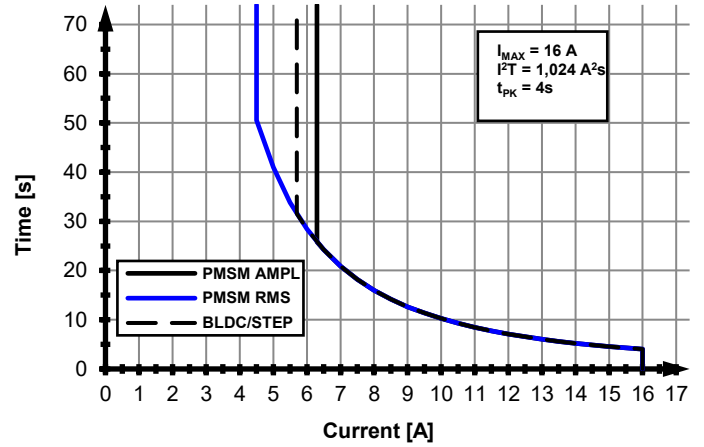

Micro 4804 MZ

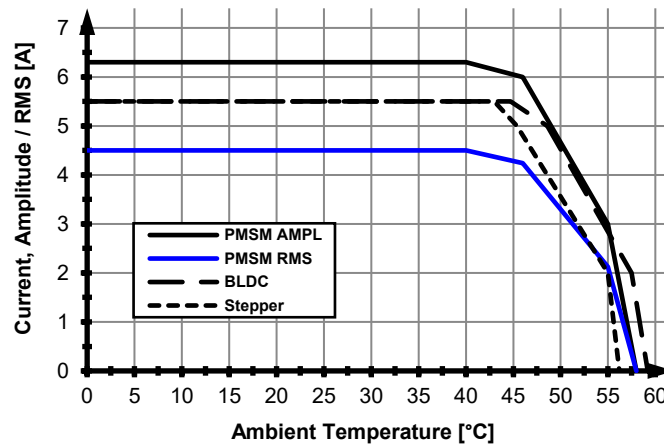

Name ALN	First edition November 3, 2023	Document template: P099.TQT.564.0001	Last edition October 18, 2024	Visa:
TECHNOSOFT		Title of document Micro 4804 MZ-CAT PRODUCT DATA SHEET	N° document P020.002.E122.DSH.10D Page: 5 of 5	